



THE MOTORCYCLE SAFETY FOUNDATION

# BASIC RIDERCOURSE<sup>SM</sup>

THE MOTORCYCLE SAFETY FOUNDATION BASIC RIDERCOURSE<sup>SM</sup>



RIDER HANDBOOK

Edition 1.0, Fifth Printing (Rev.), January 2020

© 2014 Motorcycle Safety Foundation

All rights reserved. No part of this publication may be reproduced or transmitted in any form or by any means, electronic or mechanical, including photocopy, recording, or any information and retrieval system, without permission in writing from the Motorcycle Safety Foundation® (MSF®). Under no circumstances may the material be reproduced for resale. Please send request by email to: [training-systems@msf-usa.org](mailto:training-systems@msf-usa.org).

Portions of this book may be reproduced by the Motorcycle Safety Foundation certified RiderCoaches solely to facilitate their presenting this MSF Basic *RiderCourse*<sup>SM</sup>. Under no circumstances may a RiderCoach reproduce this material in its entirety.

The MSF Basic *RiderCourse* is based on years of scientific research and field experience. This current edition has been field-tested and has proven to be successful in developing the entry-level skills for riding in traffic. Through its various iterations, over seven million riders have been trained since 1973.

The information contained in this publication is offered for the benefit of those who have an interest in riding motorcycles. In addition to the extensive research and field experience conducted by the MSF, the material has been supplemented with information from publications, interviews and observations of individuals and organizations familiar with the use of motorcycles and training. Because there are many differences in product design, riding styles, and federal, state and local laws, there may be organizations and individuals who hold differing opinions. Consult your local regulatory agencies for information concerning the operation of motorcycles in your area. Although the MSF will continue to research, field-test and publish responsible viewpoints on the subject, it disclaims any and all liability for the views expressed herein.

The Motorcycle Safety Foundation® is the internationally recognized developer of the comprehensive, research-based, Rider Education and Training System (RETS). RETS curricula promotes lifelong-learning for motorcyclists and continuous professional development for certified RiderCoaches<sup>SM</sup> and other trainers. MSF also actively participates in government relations, safety research, public awareness campaigns and the provision of technical assistance to state training and licensing programs. The Motorcycle Safety Foundation is a national, not-for-profit organization sponsored by BMW, BRP, Harley-Davidson, Honda, Indian Motorcycle, Kawasaki, KTM, Suzuki, Triumph and Yamaha.

## Welcome

### Section 1. Course Introduction

Course Requirements	1
Risk and Responsibilities	1

### Section 2. Motorcycle Types

Street Motorcycles	2
Dual-Purpose Motorcycles	3
Off-Highway Motorcycles	3

### Section 3. Controls, Indicators and Equipment

Primary Controls	4
Other Controls	5
Indicators and Equipment	5

### Section 4. About Basic Operation

Engine Start and Stop	8
Clutch Lever and Friction Zone	8
Riding Posture	8
Basic Turning	9
Braking to a Stop	10
Shifting	11

### Section 5. Preparing to Ride: The Four Preps

Motorcycle Fit	12
Motorcycle Inspection and Maintenance	12
Personal Protective Gear	13
Mental Attitude	17

### Section 6. Risk and Riding

Risk Awareness	18
Risk Acceptance	18
Risk Management	18
Self-Awareness	19

### Section 7. Basic Street Strategies

Positioning	20
Being Visible	21
An Active Strategy	22

# TABLE OF CONTENTS

Mental Processing	24
Escape Paths	25
<b>Section 8. Strategies for Common Riding Situations</b>	
Intersections	26
Between Intersections	26
Blind Spots	27
Lane Changes	28
Freeway Merging and Exiting	28
Curves	28
Limited-Space Maneuvers	30
Starting on a Hill	31
Obstacles	31
Parking	31
Road Furniture	31
Passing	32
Tailgaters	32
Night Riding	32
Group Riding	33
<b>Section 9. Basics for Emergencies</b>	
Braking Systems	34
Emergency Stop in a Straight Line	34
Emergency Stop in a Curve	34
Front Tire Skid	34
Rear Tire Skid	34
Swerving	35
The Brake or Swerve Decision	35
<b>Section 10. Special Riding Situations</b>	
Road Surfaces	36
Carrying Passengers or Cargo	37
Touring	38
Wind	38
Animals	38
Maintenance and Emergency Issues	38
<b>Section 11. Rider Impairments</b>	
Alcohol	40

Drugs	40
Intervention	41
Other Factors Affecting Safety	41
<b>Section 12. Select Topics</b>	
Licensing Information	43
Personal Protective Gear Requirements	43
State Motorcycle Equipment Requirements	43
State Insurance Requirements	43
Consequences for Impaired Riding	43
<b>Section 13. Key Safety Concepts</b>	
Self-Assessment	44
Terms and Concepts from the Course	44
<b>Section 14. Knowledge Test</b>	45
<b>Section 15. Next Steps</b>	46
<b>Section 16. Range Preparation</b>	
Range Safety Rules	48
RiderCoach Signals	48
How the Range Exercises Work	49
<b>Glossary</b>	50
<b>Study Questions</b>	53
<b>Activity Sheets</b>	59
<b>MSF Lifelong Learning Resources</b>	
iPhone and iPad Apps	71
iBooks	71
Instructional Video	71
iTunes U - Free Online Courses	72
Textbook	72
Host-An-Event Kits	73

# WELCOME

Welcome to the world of motorcycle riding. The Motorcycle Safety Foundation® (MSF) and your course sponsor want you to learn to be the wisest rider possible. We want motorcycling to be seriously fun for you. Serious because there is risk involved. Fun because riding a motorcycle is a joy.

If you are new to riding, welcome to the challenge. You must be able to balance a two-wheel bicycle before riding a motorcycle in this course. The Basic *RiderCourse*<sup>SM</sup> (BRC) will help you learn the physical and mental skills required to enjoy riding to the fullest as well as challenge you to be the best you can be as a lifelong learner.

If you are a returning rider who has not ridden for some time, welcome back. This course will help you renew skills that can improve your safety and risk management, and make riding more fun.

If you are an experienced rider here to earn your license or endorsement, you will fine-tune your skills and learn new strategies for the road. Challenge yourself to master the basics. Be a good example for the new riders.

This is the Basic *RiderCourse*, so it provides the basics. The classroom activities introduce the mental and perceptual processes needed to be a good rider and show you how to process information and make safe decisions. The riding sessions have you practice basic control that includes clutch and throttle coordination, straight-line riding, stopping, turning, and shifting. Also included are quicker stops, curves, and swerves. It is important not only to be healthy, but to have enough fitness, strength, and coordination to learn well and manage the physical demands of riding a motorcycle.

Your RiderCoaches are here to guide you. Ask a lot of questions and let them know how to help you. You will have your questions answered and your progress observed. In the classroom, there will be discussions supported by a variety of activities. On the range, the off-street riding area, you will work on skills to help you handle common riding tasks.

This course will provide a good start, but it is important for you to continue to practice the basics of riding on your own motorcycle. The MSF offers more advanced training as part of its complete Rider Education and Training System<sup>SM</sup>. You want to keep your skills fresh. You want to be sharp. After you have successfully completed the Basic *RiderCourse*, a good next step after getting licensed is to enroll in the MSF Street *RiderCourse* or Basic Bike Bonding *RiderCourse*, and consider our online courses too. Check with your RiderCoach about availability.

## COURSE REQUIREMENTS

Successful completion of the BRC requires you to: (1) complete all course assignments, (2) attend all sessions in their entirety, (3) pass a knowledge test, and (4) pass an on-motorcycle skill test that consists of exercises from the course. Note your course schedule and directions to the riding range here:

---

---

---

Completing the BRC does not guarantee you will be safe on the road. You are responsible for your own safety. This course provides the basics that allow you to continue to practice your skills and strategies on your motorcycle. Besides following legal requirements, safe riding is a matter of riding within your limits, and only you can choose to do that. You might even decide that riding a motorcycle on the street is not right for you.

## RISK AND RESPONSIBILITIES

Safety and learning are responsibilities shared by you, your RiderCoaches, and your classmates. You are not competing with anyone else in this course so you should focus on your own learning. Ultimately, you are responsible for your own safety and learning. You must let a RiderCoach know if you become uncomfortable or are thinking about leaving the course. There is nothing wrong with that choice. Choose safety first.

Your safety is the highest priority in the Basic *RiderCourse*. RiderCoaches must continuously observe and evaluate you to ensure you meet minimum aptitude requirements for your safety and the safety of others on the range. Because learning a motor skill is an inherently risky activity, there may be instances when a participant loses control.

The Basic *RiderCourse* is conducted at a pace that results in successful completion for most new riders. The RiderCoaches will help you learn to the best of your ability, but if you have a lot of difficulty or become a risk to yourself or others on the riding range as determined by you or your RiderCoaches, you will not be permitted to continue to ride. If this happens, your pursuit of learning to ride may not be over, as many students are successful on a second attempt, and other learning options may be available. RiderCoaches will do their best to keep your experience positive.



## SECTION 2. MOTORCYCLE TYPES

**Introduction:** A motorcycle is a single-track, two-wheel vehicle designed to be straddled by its rider and having handlebars for control, but variations exist such as three-wheel designs. The three basic motorcycle types are: (1) street, (2) dual-purpose, and (3) off-highway. Street motorcycles are designed for use on public streets. Dual-purpose motorcycles can be used on the street or on off-highway trails. Off-highway motorcycles are not street-legal. Each type of motorcycle is available in a variety of styles and sizes. For example, street motorcycles include cruisers, sport bikes, and touring bikes. Shopping to find the right one for you can be a lot of fun. See below for motorcycle characteristics.

### STREET MOTORCYCLES

#### Standard

- All around capabilities
- Sometimes called a naked bike (minimum use of body panels)
- Straight-up seating position
- Various engine sizes



#### Sport

- Body panels and fairing for aerodynamics
- Rear-positioned footrests
- May have higher power-to-weight ratio
- Forward-leaning seating position

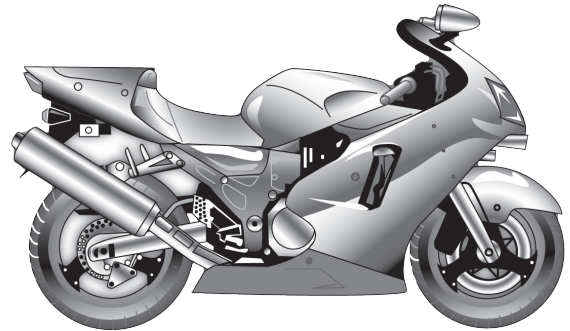

#### Cruiser

- Usually has "classic" styling
- Forward footrests
- Swept back handlebars
- Rearward-leaning seating position

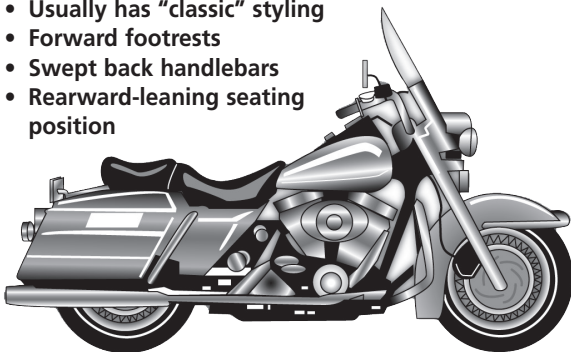

#### Touring

- Designed for comfort and riding longer distances
- Large engine
- Large wind-deflecting fairing
- Heavier than most other motorcycle types
- Bags for additional storage space

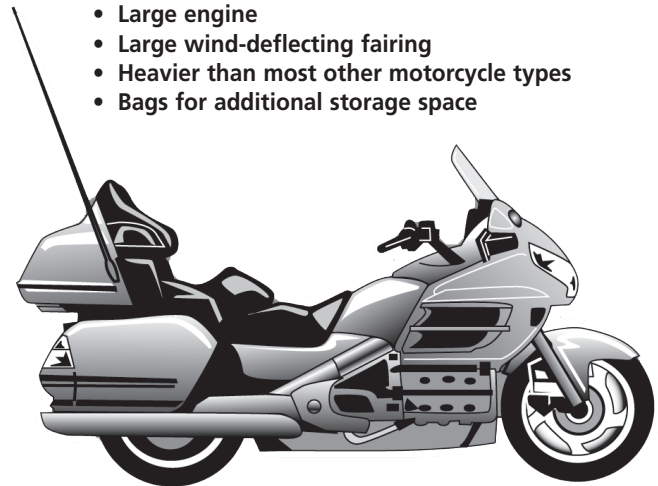

#### Scooter

- Step-through design, often with under-seat storage
- Usually has smaller wheels
- Most have automatic transmission

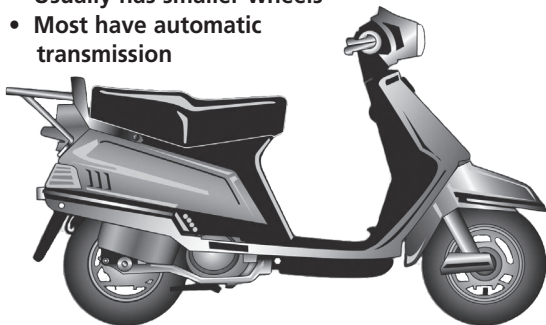

### DUAL-PURPOSE MOTORCYCLES

- Used for both street and off-highway riding
- Various engine sizes, up to large adventure-touring models
- Tall seating and straight-up seating position
- Special tires provide grip on pavement and dirt
- Extra ground clearance and long-travel suspension



### OFF-HIGHWAY MOTORCYCLES

#### Enduro

- Recreational riding in forests or deserts
- Some have a headlight and taillight



#### Motocross

- Closed course competition over bumps and jumps



#### Trials

- Low-speed competition over challenging obstacles



## SECTION 3. CONTROLS, INDICATORS AND EQUIPMENT

**Introduction:** Hands and feet are used to operate and control a motorcycle. You must know the location and operation of the primary controls and be smooth and precise when using them. The controls and equipment described here are for motorcycles with a gasoline-powered engine and a manual transmission. (Some motorcycles have an electric motor and/or automatic transmission.)

### PRIMARY CONTROLS

There are six primary controls. You should know the location and function of each control. You will practice using these on the range.

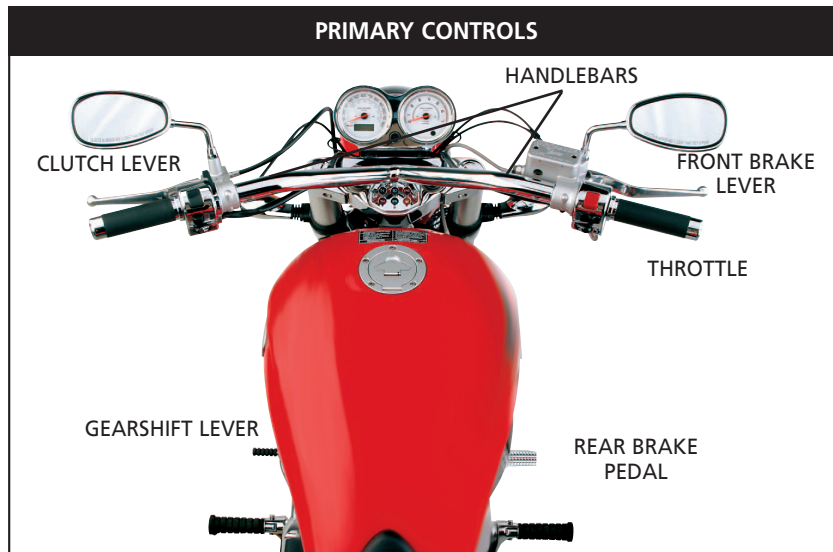

**Handlebars:** Used to control direction of the motorcycle. There is a handgrip on each end.

**Throttle:** The right handgrip, which rotates to control engine speed. To increase engine speed, twist it toward you (*roll on*). To decrease engine speed, twist it away from you (*roll off*). The throttle springs back to the idle position when released.

**Clutch Lever:** In front of the left handgrip. It is operated with the fingers of the left hand. The clutch mechanism connects power from the engine to the rear wheel. The lever is squeezed in to disconnect and eased out to connect. When the clutch lever is squeezed in, there is no engine power going to the rear wheel. Scooters and some motorcycles do not have a clutch lever because they have an automatic transmission.

**Gearshift Lever:** On the left side of the motorcycle in front of the left footrest. It is operated with the left foot. Lift up firmly and release to go to a higher gear; press down firmly and release to go to a lower gear. It shifts one gear with each lift or press, and only needs to move up or down an inch or so. When released, it returns to its center position for the next shift. Most motorcycles have five or six gears with 1st gear at the bottom. Neutral is between 1st and 2nd gear and is selected by either a half lift from 1st gear or a half press from 2nd gear. Most scooters and some motorcycles do not have a gearshift lever because they have an automatic transmission.

**Front Brake Lever:** In front of the right handgrip and operated with the fingers of the right hand. Squeeze it in to operate. It is used a bit differently than the clutch lever as it doesn't reach the handgrip, and the amount of squeeze must be adjusted for effective braking. While learning to ride, keep your fingers wrapped around the handgrip for throttle control and so you can learn to reach-and-squeeze the front brake lever when needed.

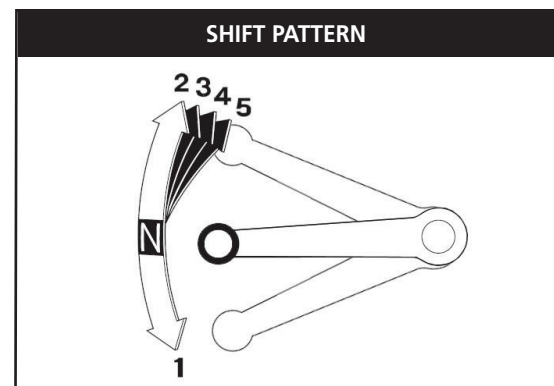

## SECTION 3. CONTROLS, INDICATORS AND EQUIPMENT

**Rear Brake Pedal:** In front of the right footrest and operated with the right foot. Press down to operate it.

### OTHER CONTROLS

The location and operation of other controls may vary. The best source of information is the motorcycle owner's manual. Other controls include:

**Fuel Supply Valve:** Usually under the fuel tank. It controls the flow of gasoline to the engine. Common positions are: *On*, *Reserve*, and *Prime* or *Off*. *Reserve* allows access to a small amount of fuel after the main supply is depleted. *Prime* permits direct fuel flow, and the valve should not be left in this position after its use. Some motorcycles do not have this valve because the engine is fuel-injected, and gasoline only flows when the ignition switch is *On* and the engine is running.

**Ignition Switch:** Often located near the instrument cluster. Positions include *On*, *Off*, and *Lock*, and some include a *Park* position. The *Lock* and *Park* positions engage the steering lock and allow the key to be removed. The *Park* position turns on the taillight for better visibility when parked for a short time on the side of the road. The switch may also have an *Accessory* position.

**Choke Control:** Located on the handlebars or near the engine. It provides an enriched fuel mixture to help start a cold engine. It also raises the idle to permit the engine to warm quickly. It should be turned *Off* as soon it is no longer needed. Fuel-injected motorcycles do not have a choke control.

**Engine Cut-off Switch:** Near the right handgrip and operated with the thumb. It allows you to shut off the engine without removing your hand from the handgrip.

**Turn Signal Switch:** Usually located near the left handgrip and operated with the thumb. Some signals cancel automatically after a turn or lane change.

### INDICATORS AND EQUIPMENT

Motorcycles include indicators that display information. They also have equipment to aid in safe operation and to communicate with others.

**High/Low Beam Switch:** Near the left handgrip and operated with the thumb. It is used to select high or low beam for the headlight.

**Horn Button:** Located near the left handgrip and operated with the thumb.

**Engine Start Button:** Located near the right handgrip and operated with the thumb.

**Speedometer:** Part of the instrument cluster and shows road speed.

**Odometer:** Part of the instrument cluster and shows miles ridden. There may also be a re-settable trip meter, which can be used to display miles traveled since the last fill-up or the last stopping point.

**Tachometer:** Indicates engine speed in revolutions per minute (rpm). It has a red line for maximum engine speed that should never be exceeded.

**Indicator Lights:** May include neutral, high beam, turn signal, oil pressure, side stand down, and more. Check the motorcycle owner's manual.

**Motorcycle Lights:** Includes headlight, turn signals, taillight, and brake light. Check for proper operation. Be sure that squeezing the front brake lever and pressing the rear brake pedal illuminate the brake light.

**Mirrors:** Help you see what is behind you. Motorcycles have convex mirrors that are curved to provide a wider view but make objects look farther away. Convex mirrors may reduce the size of blind spot areas, but they do not eliminate them.

FUEL SUPPLY VALVE IN OFF POSITION

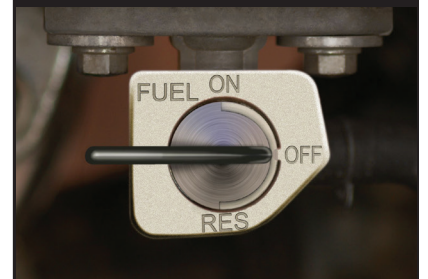

FUEL SUPPLY VALVE WITH PRIME

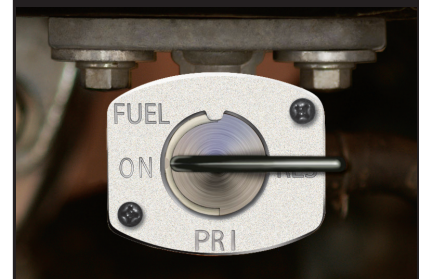

IGNITION SWITCH



## SECTION 3. CONTROLS, INDICATORS AND EQUIPMENT

**Side Stand:** Supports the motorcycle when parked. Some motorcycles may also have a center stand that keeps the motorcycle upright and more stable, with the rear tire slightly off the ground. This is helpful for some maintenance procedures.



# SECTION 3. CONTROLS, INDICATORS AND EQUIPMENT

## Controls Quiz

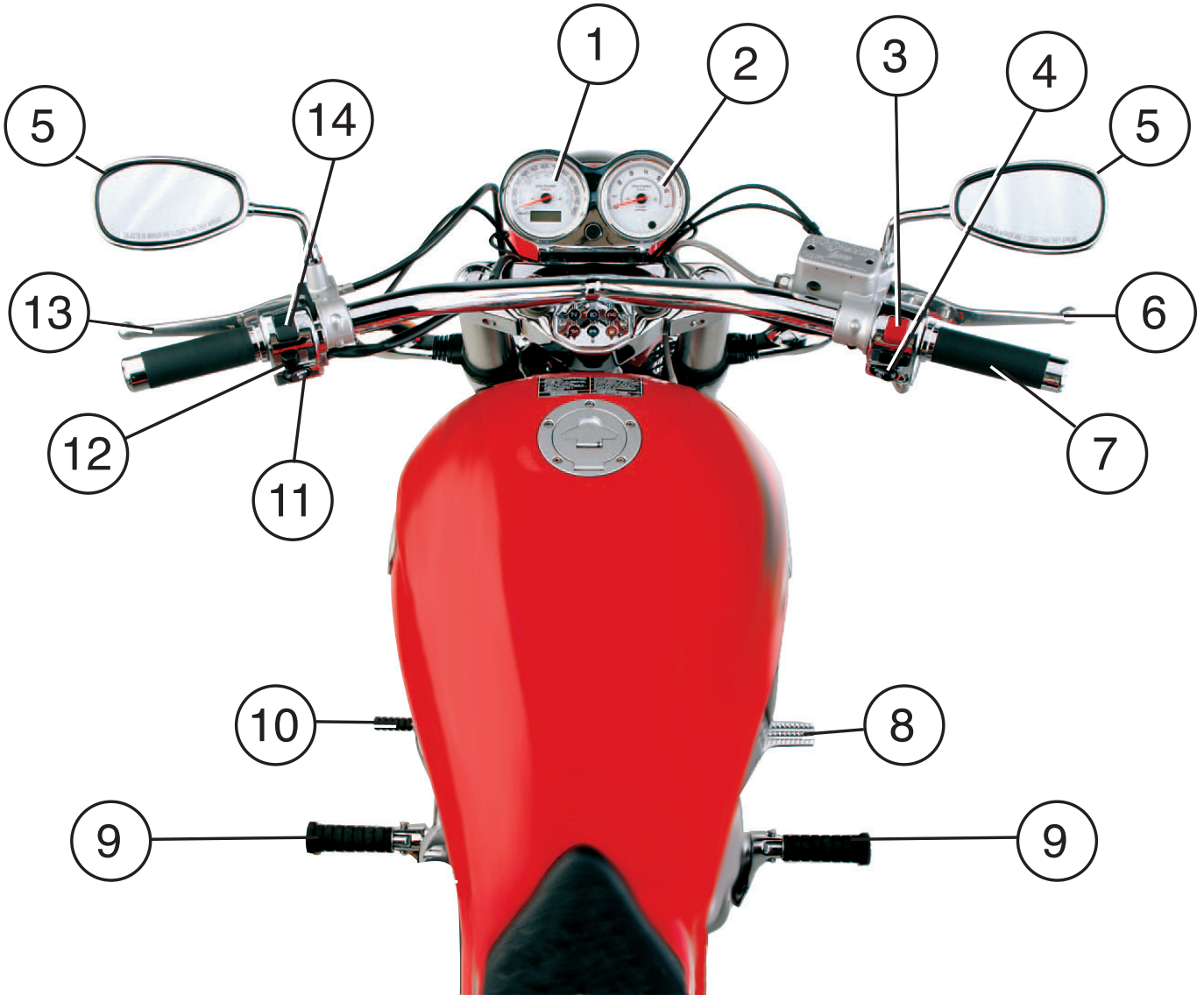

- 1. \_\_\_\_\_
- 2. \_\_\_\_\_
- 3. \_\_\_\_\_
- 4. \_\_\_\_\_
- 5. \_\_\_\_\_
- 6. \_\_\_\_\_
- 7. \_\_\_\_\_
- 8. \_\_\_\_\_

- 9. \_\_\_\_\_
- 10. \_\_\_\_\_
- 11. \_\_\_\_\_
- 12. \_\_\_\_\_
- 13. \_\_\_\_\_
- 14. \_\_\_\_\_

## SECTION 4. ABOUT BASIC OPERATION

**Introduction:** This section provides basic knowledge for learning to ride. The information will help when you first learn to operate a motorcycle in this course.

### ENGINE START AND STOP

A procedure called **FINE-C** is used as an engine pre-start routine. It stands for Fuel, Ignition, Neutral, Engine Cut-off Switch, and Choke/Clutch.

**Fuel:** If equipped, turn the fuel supply valve *On*.

**Ignition:** Turn ignition switch to the *On* position. Some indicator lights should come on.

**Neutral:** Be in neutral. The green light in the instrument cluster indicates neutral. When in neutral, the motorcycle will roll forward and backward with the clutch lever, front brake lever, and rear brake pedal released.

**Engine Cut-off Switch:** Put the switch in the *Run/On* position.

**Choke/Clutch:** Set the choke as needed (*On* for a cold engine). Some motorcycles do not have a choke. Also, many motorcycles require the clutch lever to be squeezed to start the engine.

When you start the engine, apply at least one of the brakes, squeeze in the clutch lever fully, and press the starter button. Do not use the throttle if using the choke since this could provide an incorrect fuel/air mixture. Once the engine is started, you can release the clutch lever, but do so slowly in case the motorcycle is not in neutral.

Some engines will not start if the side stand is down. Many motorcycles will allow the engine to start but will stall when the motorcycle is shifted into gear if the side stand is down.

To stop the engine, first move the engine cut-off switch to *Off* with your right thumb. Do this every time so you can develop the habit in case you need to shut off the engine for an emergency. Then turn the ignition switch to *Off*. Turn the fuel supply valve to *Off* if it has that position. An easy way to remember this is "Thumb, key, valve."

### CLUTCH LEVER AND FRICTION ZONE

Proper use of the clutch lever and friction zone is critical for starting out smoothly and for slow speed maneuvers. The friction zone is a small area in the travel of the clutch lever that controls the connection between the engine and the rear wheel. Fully squeezing in the clutch lever removes power from the rear wheel. If you lose control of the motorcycle while riding in this course, you should squeeze in the clutch lever fully and use the brakes as needed.

### RIDING POSTURE

Good posture helps you control the motorcycle. Keep your back straight and head and eyes up. Keep both feet on the footrests and near the controls. Keep your knees and elbows in. Arms should be relaxed and bent. Keep your fingers around the throttle with your wrist flat.

As you are learning to ride, it may be helpful to keep the fingers of your left hand over the clutch lever (cover the clutch lever). This is so you can readily remove power from the rear wheel.

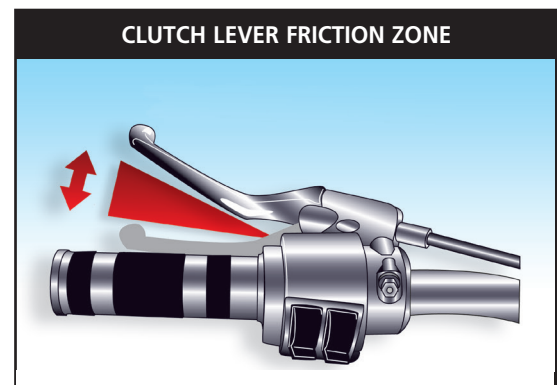

### BASIC TURNING

Like riding a bicycle, a motorcycle requires you to balance it. Steering a motorcycle involves proper use of the handlebars. Because a motorcycle is heavier and more powerful than a bicycle, it is important to learn precise steering control.

Whether called a turn, corner, or curve, changing direction requires special attention. When riding a motorcycle at very low speed (like walking speed), change direction by leaning the motorcycle and turning the handlebars in the direction you want to go. At higher speeds, you initiate a change of direction by first pressing (forward or down) the handgrip on the same side of the intended turn. This is called countersteering because the handlebars are initially moved opposite the direction of the turn.

As you learn the skills needed to change direction, you want to consider:

(1) speed, (2) where to scan, (3) handlebar movement, and (4) throttle use. Think about it in this order: Slow, Look, Press, and Roll. Although in reality these may not always be distinct steps and they may overlap, they make a good starting point when learning the basics of turning.

**Slow:** Reduce speed if needed before entering a turn by rolling off the throttle and using the brakes as needed.

Sometimes downshifting to a lower gear is necessary, and this should be done before the turn begins. You want to set up for the turn by having a safe entry speed. A safe entry speed is the speed at the beginning of the turn that allows you to maintain or increase speed while in the turn.

**Look:** As you approach a curve, evaluate its features ahead of time: sharpness or radius, length, surface conditions, etc. As you near the entry point, continue to search by keeping your head up and eyes moving throughout the turn. Turning your head in the direction of the turn helps you keep a good visual picture. Continuously scan far and near as well as to the sides. Notice where the turn ends and what is after the turn.

**Press:** To initiate motorcycle lean, first press forward on the handgrip in the direction of the turn. Press left handgrip, lean left, go left. Press right handgrip, lean right, go right. Then adjust your steering to maintain the path of travel.

**Roll:** Use the throttle to maintain or slightly increase speed. Avoid quick or sudden throttle roll-on or roll-off that would affect smoothness as this influences the suspension and tire grip.

A good overall cornering strategy to use is Search-Setup-Smooth. Search: while approaching and going through a curve, scan for key information. Setup: adjust speed and lane position as necessary before entering. Smooth: operate the controls so there are no jerky movements.

For normal street speeds, you and the motorcycle should lean together. However, for slow, tight turns like a U-turn in a parking lot, you can lean independently from the motorcycle (counterweighting). This permits more motorcycle lean for a sharper turning radius. Putting more pressure on the outside footrest can also help.

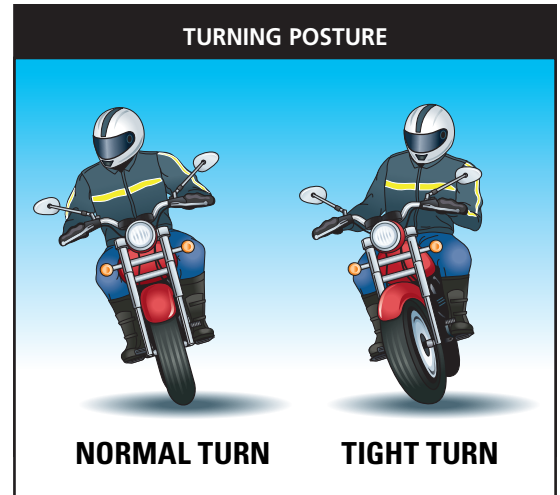

## SECTION 4. ABOUT BASIC OPERATION

### BRAKING TO A STOP

Slowing does not always require the clutch lever to be squeezed. But when braking to a stop, roll off the throttle, and squeeze in the clutch lever and the front brake lever while pressing on the rear brake pedal. Your left foot should touch the ground first so you can use the rear brake pedal until completely stopped. You should be in first gear by the time you stop. It is important to square the handlebars (center the steering) so the motorcycle is easier to hold up. Be sure not to release the clutch lever until you are ready to move out.

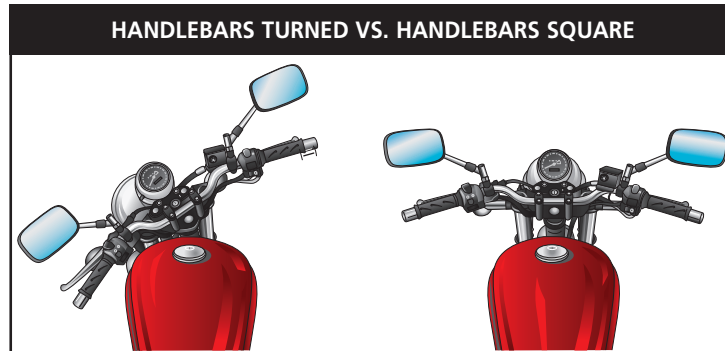

When braking to a stop in a curve, gradually apply both brakes as you straighten the motorcycle. The motorcycle should be straight up and the handlebars should be square before you come to a complete stop. Be sure to downshift and keep the clutch lever squeezed in.

The front brake provides 70 percent or more of the stopping power. This is because forward weight shift pushes the front tire down onto the road surface, giving it more grip than the rear tire.

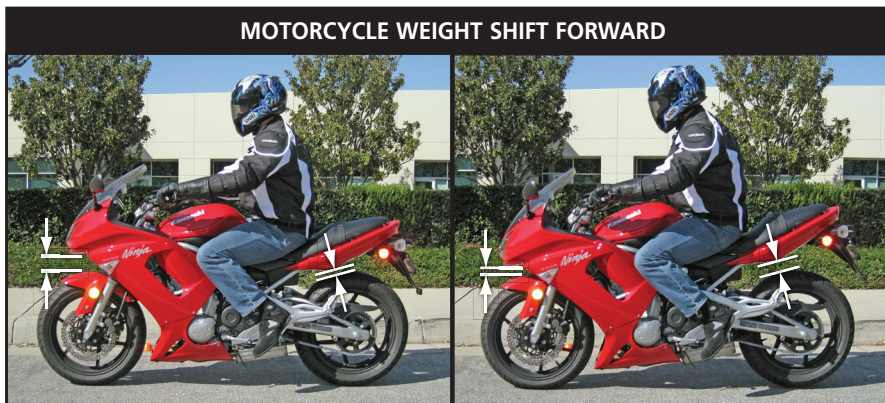

Usually, both brakes are applied at the same time when stopping, but either brake control may be used separately. Full braking power is not required for normal, planned stops. However, it is important to develop the habit of using both brakes so you can use them properly if a quick stop is needed.

Learn to make smooth, controlled stops before practicing quicker stops. It is important to have a good feel for the brake controls. Too much pressure too quickly could cause a skid and loss of control or a fall. While you are learning the basics of stopping quickly, keep speeds low and gradually develop a precise feel for the brake controls.

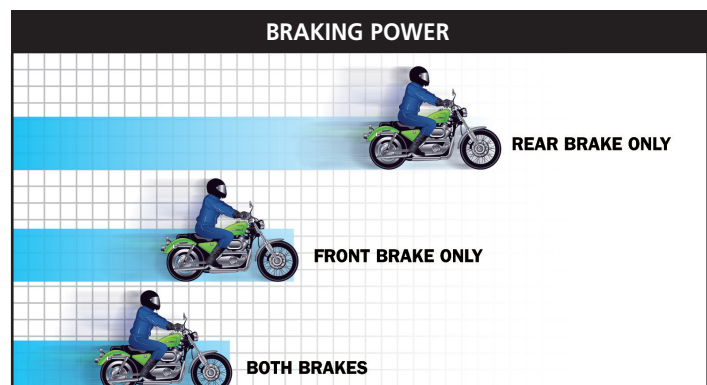

### SHIFTING

You change gears to match engine speed (rpm) to road speed. Lower gears are used for lower speeds, and higher gears are used for higher speeds.

Shifting to a higher gear: Shift up soon enough to avoid over-revving the engine (high rpm) but not so soon as to cause the engine to operate at too low an rpm (jerky or lugging motion).

Use a three-step process to shift to a higher gear:

1. **Roll off** the throttle as you squeeze in the clutch lever,
2. **Lift** the shift lever firmly as far as it will go, then release it to allow it to reset,
3. **Ease out** the clutch lever and roll on the throttle smoothly to match engine and road speed.

Shifting to a lower gear: Be sure the road speed is slow enough so you do not over-rev the engine or cause the rear wheel to skid as you release the clutch lever.

Use a three-step process to shift to a lower gear:

1. **Roll off** the throttle as you squeeze in the clutch lever,
2. **Press** down the shift lever firmly, then release it to allow it to reset,
3. **Ease out** the clutch lever as you roll on the throttle. If you roll on the throttle slightly as you ease out the clutch lever, you can help engine speed come up to road speed, making the downshift process smoother.

Shifting to a lower gear and easing out the clutch lever has an effect similar to using the brakes. This is known as engine braking. To use engine braking, shift down one gear at a time and ease out the clutch lever through the friction zone between each downshift. Coordinate the use of the clutch lever and throttle to keep the process smooth. It is possible to shift down more than one gear at a time when the clutch lever is squeezed.

When learning to shift gears, shift only when going straight. Shifting while leaned over can complicate the smooth process. Once you have learned to downshift well and gained some experience, you will have the choice to downshift more quickly by using a quick throttle blip (a quick roll-on of the throttle) before easing out the clutch lever to control the amount of engine braking and match the engine speed to road speed more smoothly.

When making a complete stop, the clutch lever must be fully squeezed to disconnect power from the rear wheel. The clutch lever remains squeezed until you are ready to start out in 1st gear.



## SECTION 5. PREPARING TO RIDE: THE FOUR PREPS

**Introduction:** Being prepared to ride before you start the engine increases safety and fun. This includes being strong enough to hold the motorcycle upright and having the fitness and coordination to properly manipulate the controls. Preparation includes making sure that:

1. You fit the motorcycle.
2. You inspect the motorcycle.
3. You use proper protective riding gear.
4. You have a good mental attitude with safety as your priority.

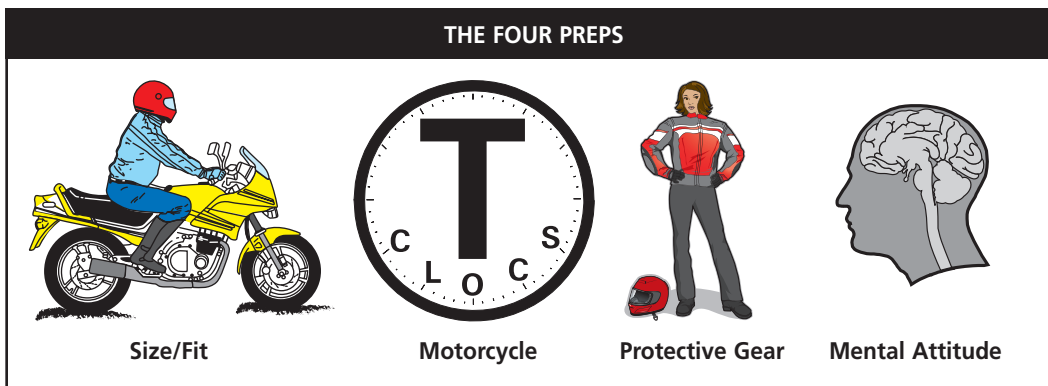

### MOTORCYCLE FIT

Your motorcycle should be one you can handle well. Two primary features to consider are seat height and overall motorcycle size. The seat should be low enough so you can reach the ground and support the motorcycle. Overall motorcycle size generally refers to engine size, which is measured in cubic centimeters (cc's) or in cubic inches. Motorcycles with larger engines are generally heavier and more powerful than those with smaller engines. Pick a size that is right for your strength and skill level so you can handle it well. You may be able to adjust the controls or replace the seat to fit you better.

### MOTORCYCLE INSPECTION AND MAINTENANCE

A pre-ride inspection helps keep your ride safe and trouble-free. It helps ensure your motorcycle will run properly and prevent you from being stuck on the side of the road. It can also save you money. The best source of information is the motorcycle owner's manual. A pre-ride inspection should be as routine as brushing your teeth. It is easy to check important parts. A good method is called T-CLOCS<sup>SM</sup>. Here is a T-CLOCS inspection list. Each item should be checked before every ride.

- T – Tires and Wheels
  - Air pressure
  - Tread
  - Cracked sidewalls, dented wheels, loose spokes
- C – Controls
  - Levers and pedals
  - Cables
  - Hoses
  - Throttle
- L – Lights and Mirrors
  - Headlight
  - Taillights and brake lights
  - Turn signals
- O – Oil and Other Fluids
  - Levels
  - Leaks
- S – Stands
  - Side stand (kickstand)
  - Center stand
- Switches
- Mirrors
- C – Chassis
  - Suspension
  - Chain, belt, or driveshaft

## SECTION 5. PREPARING TO RIDE: THE FOUR PREPS

A pre-ride inspection only takes a few minutes. It helps you find problems before they become serious. You can download a more detailed T-CLOCS reference page at [https://msf-usa.org/downloads/T-CLOCS\\_Inspection\\_Checklist.pdf](https://msf-usa.org/downloads/T-CLOCS_Inspection_Checklist.pdf).

Routine maintenance goes beyond a pre-ride inspection. Wear and tear is normal over time, and routine maintenance helps prevent the need for more costly corrective maintenance. The schedule for regular upkeep is provided in the motorcycle owner's manual.

### PERSONAL PROTECTIVE GEAR

Many activities and sports require protective gear. Riding a motorcycle does, too. Even a low-speed fall can leave you scraped, bruised, or worse. Crashing at higher speeds and hitting the ground or another vehicle can be disastrous.

Riding is more enjoyable when proper gear is used, and it can make a huge difference in a crash. Quality riding gear helps keep you comfortable and focused, helps keep your body protected, and may help you be much more visible in traffic.

You want to be seen by car drivers. Your helmet and jacket should be brightly colored and have reflective material, especially if you ride at night. Consider clothing with body armor (rigid inserts that help protect your spine, elbows, knees, and other areas). The right gear helps in all riding conditions. In the event of a crash, it may reduce or prevent injuries. You should dress for a crash as well as for the ride.

Every rider and passenger should wear a quality helmet built for riding a motorcycle. Added should be proper eye protection, sturdy over-the-ankle footwear with non-slip soles, long pants that will hold up in a slide, a good jacket, and full-fingered gloves. This is often referred to as ATGATT: All The Gear, All The Time.

### Head and Brain Protection

A helmet helps protect the head and brain from injury. The critical importance of a helmet has been confirmed by laboratory tests and decades of crash studies. Some myths about helmets: they cause neck injury, block vision, or impair hearing. The truth is helmets have been shown to reduce neck injuries because the helmet absorbs the initial impact, causing the neck to receive less force. Under the U.S. Departments of Transportation standards, helmets are required to allow at least 105° of peripheral vision to each side. Helmets do not impair hearing because they reduce wind and engine noise without affecting the ability to hear traffic.

A head injury is the primary cause of death for riders. Even the best helmet is no guarantee against injury, but proper helmet use has been shown to reduce the risk of brain injury by 67 percent and the risk of death by 37 percent (U.S. Department of Transportation).



## SECTION 5. PREPARING TO RIDE: THE FOUR PREPS

### Helmet Basics

There are four basic parts of a helmet:

1. Outer shell: Keeps objects from reaching the head and absorbs impact. If a helmet has an impact, it should be inspected and replaced as necessary. Damage may not be visible.
2. Impact-absorbing liner: Made of material that absorbs shock. It works with the outer shell to spread impact forces throughout the helmet. If more energy is deflected or absorbed, there is less force applied to the head and brain.
3. Comfort padding: The soft foam and cloth layer next to your head. It helps with comfort and fit and can often be removed for cleaning.
4. Retention system: Fastens the helmet on your head. It is commonly a chinstrap with D-rings. If a helmet is not secured well it may come off during a crash, and its protection is lost.

These parts work together to provide comfort and protection.

### Choosing a Helmet

While color, design, and price will be a part of the decision about your helmet, protection should be considered first. A full-face helmet gives the most protection since it covers all of the head, face, and chin. These have a flip-up face shield to protect the eyes, and some have a modular design in which the front portion of the helmet flips up. A full-face helmet also provides better protection from flying objects.

A three-quarter or open-face helmet is made with the same basic parts, but it does not offer the same level of protection for your face and chin. If you wear an open-face helmet, you should use a snap-on face shield or goggles.

It is important to use a well-made helmet. Look for a U.S. Department of Transportation (DOT) designation, which is usually a sticker on the back of the helmet. This means that the manufacturer represents that they made the helmet to meet safety test standards required by federal law for helmets sold in the U.S. Some helmets may also meet other standards, such as those from the Economic Community of Europe (ECE) or Snell Memorial Foundation. Beware of helmets with fake DOT compliance stickers. If in doubt, look for the label inside the helmet under the comfort liner.

A helmet should fit snugly and not have any irritating pressure points. A well-fitting helmet will not rotate around your head if you move it from side-to-side and forward and back. With the retention system securely fastened, you should not be able to roll the helmet off your head.

Helmets vary in price, color, and design. Choose a bright helmet and add reflective material, especially if you ride at night.

### Helmet Care

Be sure to follow helmet care instructions that come with a helmet. Don't use any harsh chemicals for cleaning. Instead of scraping off dried bugs, leave a damp towel on the helmet for a few minutes, then wipe it off. Helmet components, especially the liner, can wear out due to normal use and humidity. Wash removable pads as needed and use products to eliminate bacteria and mildew. When replaceable parts are needed, use those available from the helmet manufacturer. When you put the helmet down, put it bottom-side down. Don't balance the helmet on your bike and risk having it fall. If you drop a helmet, check the shell and visor for damage.

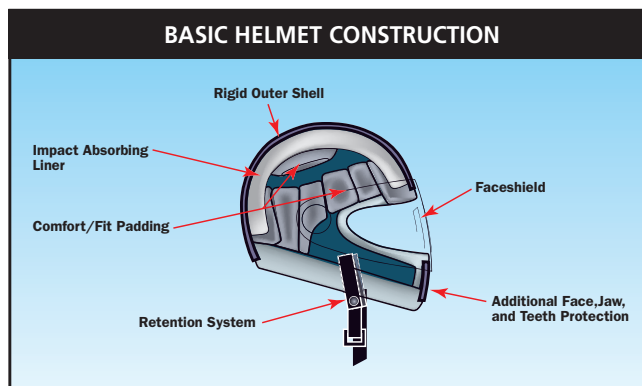

## SECTION 5. PREPARING TO RIDE: THE FOUR PREPS

Modifying a helmet can make it unsafe. Do not drill holes, modify the retention system, paint it, or attach items to the exterior. Check with the manufacturer about installing communication devices. And if your helmet has an impact while you are wearing it, it probably needs to be replaced. A helmet will not last forever and should eventually be replaced.

### Eye and Face Protection

Any rider who has been hit by a stone or insect while riding can tell you about the value of eye and face protection. Glasses or sunglasses may not seal out wind and dust. A motorcycle windscreen can allow wind and debris behind it. There is no substitute for an impact-resistant face shield or goggles to protect your eyes.



### Face Shields

Face shields come in a variety of designs. Those that flip up should be down while you ride. It should be impact-resistant and free of scratches. A tinted shield is for daytime use only. A clear shield should be used for night, low-light, and limited visibility conditions.

### Goggles

Goggles offer good eye protection, but they do not protect you from possible injuries to other areas of the face. Goggles are worn over the helmet and should be securely fastened. Goggles should not be scratched or dirty. They should not be tinted if used at night, in low light, or in limited visibility conditions.

### Body Protection

Body protection consists of clothing to keep you safe and comfortable. It helps you if you fall and during all kinds of weather conditions. If you are serious about being safe, you should be serious about choosing good body protection.

### Footwear

Sturdy, over-the-ankle boots help protect you from many riding hazards, such as stones and hot engine parts. Rubber-soled boots with low heels provide a good grip on the pavement and help keep your feet on the footrests. In a fall, boots help provide protection against foot and ankle injuries.

### Gloves

Full-fingered motorcycle gloves that fit well protect hands from the wind, sun, heat, and cold. They improve your grip and help protect your hands if you fall. Gloves also protect from flying debris. Motorcycle gloves have seams on the outside for comfort and are curved to provide a natural fit. Some designs have built-in armor for greater protection.

If gloves are too bulky, controls may be hard to operate. If gloves are too tight, circulation could be restricted. Heavier, insulated gloves are good for cold weather. Gauntlets that cover the wrist keep cold air from going up sleeves.

### Jacket, Pants, Riding Suits

Protective clothing helps prevent injury. Clothing made of leather or durable synthetic material designed specifically for motorcycling is best.

Motorcycle clothing, whether a separate jacket and pants or an integrated riding suit, is designed to fit while in a riding position. It is

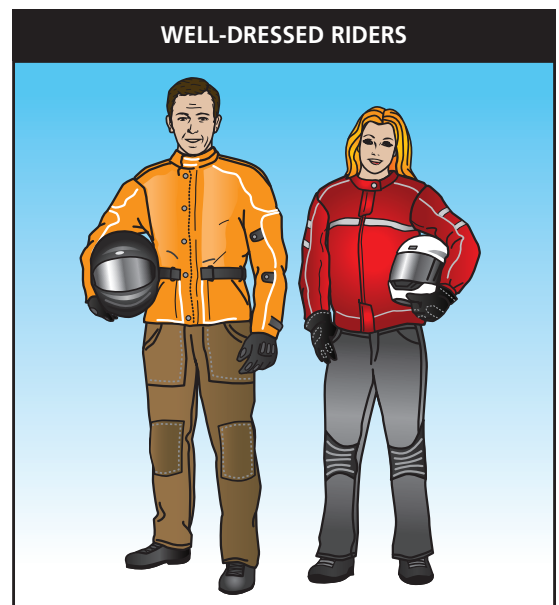

## SECTION 5. PREPARING TO RIDE: THE FOUR PREPS

cut longer in the sleeves and legs and is fuller across the shoulders. Flaps and fasteners seal out the wind, and there may be zippers for ventilation. Extra padding or “armor” provides more protection.

Avoid wearing flared pants, flowing scarves, or similar items. They can be distracting and get caught in moving parts. Regular jeans will not hold up in a crash, leaving your skin vulnerable to abrasions.

Good protective gear can make you more visible. Wear bright colors during the day. A reflective vest can be worn over darker clothing to help you be seen at night.

### Other Protection Needs

#### Rain

Riding in the rain requires a rain suit. You will be more comfortable and alert if you are not wet and chilled. One- and two-piece styles are available. Bright orange or yellow colors are good choices. Be sure to have elastic in the waist, pant legs, and sleeves for a snug and secure fit. The jacket should have a high collar and zip up with wide flaps across the opening. Adding waterproof gloves and boot covers is a good idea. Some motorcycle boots are waterproof. Your rain gear should be large enough to fit over your regular riding gear so you are still protected and stay dry.

#### Cold Weather

When riding in cold weather, protect yourself against hypothermia. Hypothermia is a lower than normal body temperature and causes loss of concentration and slower reactions. As an example, on a chilly day (40 degrees Fahrenheit), a speed of 55 MPH has a chilling effect on exposed skin of 25 degrees.

It is wise to dress in layers so you can adjust to conditions. Motorcycle overpants, and thermal-base layer shirts, pants, and jackets can be used to prevent loss of body heat. A windproof outer jacket can help prevent cold air from reaching the skin.

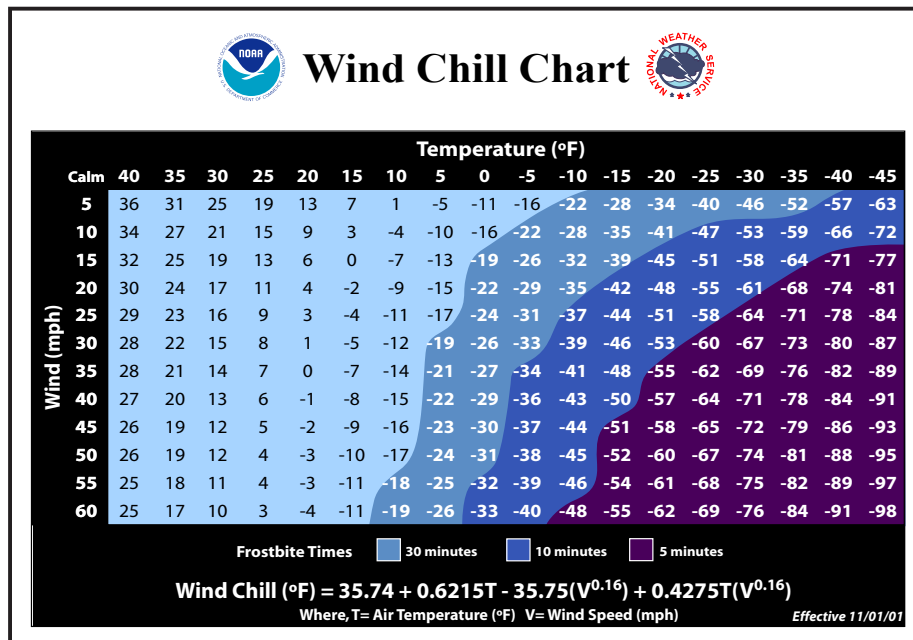

#### Hot Weather

When riding in hot weather, protect yourself from dehydration and heat exhaustion. Dehydration occurs when you do not drink enough water. Heat exhaustion is weakness caused by heat. Their symptoms include dry mouth, cramps, dizziness, and headache. Drink plenty of water. Some protective riding gear is vented to help keep you cool. You can also dampen your clothes to fight the heat. If you become too hot to ride, stop.

## SECTION 5. PREPARING TO RIDE: THE FOUR PREPS

### Hearing

While riding, you will be exposed to wind noise and engine noise that may cause hearing damage. Riding at highway speeds and riding for extended distances without using hearing protection can result in hearing loss. Earplugs will reduce damaging wind noise while still allowing you to hear important sounds like cars and sirens. You can choose from many styles. Make sure you follow state laws when using hearing protection. Remember, hearing loss is permanent.

### MENTAL ATTITUDE

A good mental attitude means safety is your #1 priority. It means you are aware of the risks in traffic and ask yourself such things as: Am I mentally ready to ride? Am I tired or stressed out? Am I confident my riding skills are sharp? Am I able to focus on safety? Riding well takes full attention.

Do not be distracted by thoughts that take away from your focus on making safe decisions.

You want to be ready to use good Rider Character – your choice to be a safe, responsible rider who does the right thing.

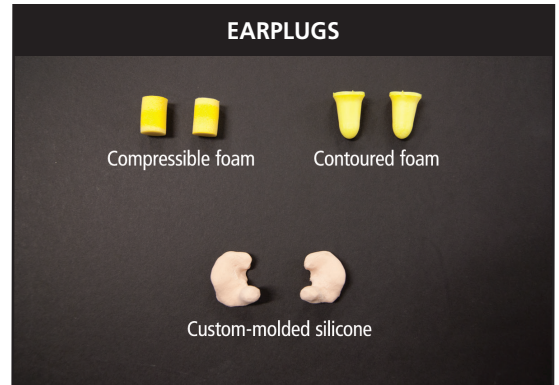

## SECTION 6. RISK AND RIDING

**Introduction:** Crashes, if they ever happen, occur mostly in curves and at intersections. Riding involves more risks than driving because:

1. The vehicle is less stable. For example, you must balance the motorcycle at lower speeds and control cornering forces at higher speeds.
2. You are more vulnerable. For example, you have no sheet metal protection, and you are more at the mercy of outside conditions.
3. You are less visible. For example, your motorcycle is smaller and narrower than most vehicles, and other roadway users may not be looking for you.

### RISK AWARENESS

What do you think causes motorcycle crashes? Perhaps you thought of speeding, lack of attention, distraction, alcohol, or carelessness. All are good answers, but consider this crash situation:

*A rider is cruising a country road at 5:00 p.m., heading home after a hard day at work. Still thinking about a problem at work, the rider rounds a slight curve in the road with an intersection ahead. There is a car stopped at a stop sign on the right and the rider thinks about slowing but figures the driver is aware. At that moment the driver pulls out. The rider tries to swerve around the car to the right, but the car stops in the middle of the lane. The front tire of the motorcycle hits the left rear of the car, sending the motorcycle out of control and into a ditch. The helmet saved the rider's head, but the rider's knees were bruised, and the bike was damaged and could not be ridden. The car driver was a young person without a license who was distracted by the glare of the setting sun. There was no alcohol involved and no one was speeding.*

What was the main cause of this crash? Since there were many reasons, or factors, it is difficult to pick a primary one. This is because there is rarely a single cause of any crash. Usually there are many factors that interact, or combine, to result in a crash.

What would have prevented this crash: Less glare? A more perceptive driver? A more attentive rider? Better skills to swerve? Remove one factor and this crash may not have happened. You do not want to ignore even minor factors because you want to break the chain of events that may lead to a crash.

### RISK ACCEPTANCE

Mobility involves risk, and the amount of risk you accept is up to you. Some people take more chances than others, and it is important for you to assess the risks you take.

As you think about being a motorcyclist, good questions to ask yourself are:

1. How good am I as a car driver?
2. Do I have many near-crashes when I drive?
3. Do I have to brake hard very often when I drive?
4. Am I easily distracted when I drive?
5. Do I have points on my driver's license?

The answers tell a lot about your risk-taking. Few riders think they will ever crash, but many riders are hurt each year. With safety as your goal, it is possible to manage the risk.

### RISK MANAGEMENT

What is a good rider? One who obeys laws? That's a start. One who has great riding skills? That's certainly helpful. One who can ride fast through turns? Not necessarily. One who looks for hazards? Of course. One who uses good judgment and rides within personal and situational limits? Absolutely.

Safe riding depends as much on the mental skills of awareness and judgement as it does on the physical skill of maneuvering the machine. You want a high level of perceptual and physical skills. Managing risk requires a rider to have three safety margins:

1. Having riding skill and motorcycle maneuverability beyond what is actually needed. You must be able to control the motorcycle well enough to put it where you want it in every situation. This means to be able to stop, turn, swerve, and accelerate with precision. For example, you must fit the motorcycle well in order to control its size, weight, and power. Ride within your skill limits by keeping in mind what you can and cannot do with the motorcycle.
2. Having traction beyond what is actually needed. Ride within traction limits. There must be enough traction for any motorcycle maneuver. For example, wet roads or low tire pressure can reduce traction.
3. Having time and space beyond what is actually needed. Have a space cushion and escape path so you can respond smoothly to situations and do not have to react quickly to an emergency. For example, there is increased risk when following too closely or riding too close to stationary objects. Never ride too fast for conditions.

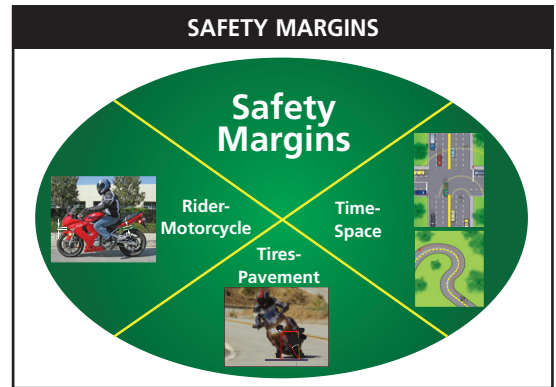

There is risk in riding a motorcycle. A rider who manages risk well has the knowledge, skills, attitude, values, and habits to be a safe and responsible rider.

## SELF-AWARENESS

Your approach to safe and responsible riding requires self-assessment: taking a look at yourself and evaluating how you are doing. How skillful are you? Will you make good choices? What action steps do you take to make safety the most important part of every ride? No matter how skillful you are, the formula for riding safely requires an honest look at what you value. Consider your general risk-taking tendencies as well as how you handle moment-to-moment choices when risk is involved.

You want to have enough skill to manage the risks you take. Risk offset is the difference between the risks you take and the skill you possess. Good risk offset is when skill exceeds risk. Bad risk offset is when risk exceeds skill. Good riders make sure they have plenty of good risk offset. Steps to find your risk offset:

1. Place a dot on the Risk Scale that represents your risk-taking. A dot in the middle indicates average risk-taking.
2. Place a dot on the Skill Scale that represents your skill. A dot in the middle indicates average skill.
3. Connect the dots with a line and extend it to show your result.
4. Risk Offset is the difference between your risk-taking and your skill.
5. If your line angles up, you are safer because there is Good Risk Offset (e.g., green dashed lines).
6. If your line angles down, you are prone to crashing because there is Bad Risk Offset (e.g., red dashed lines).

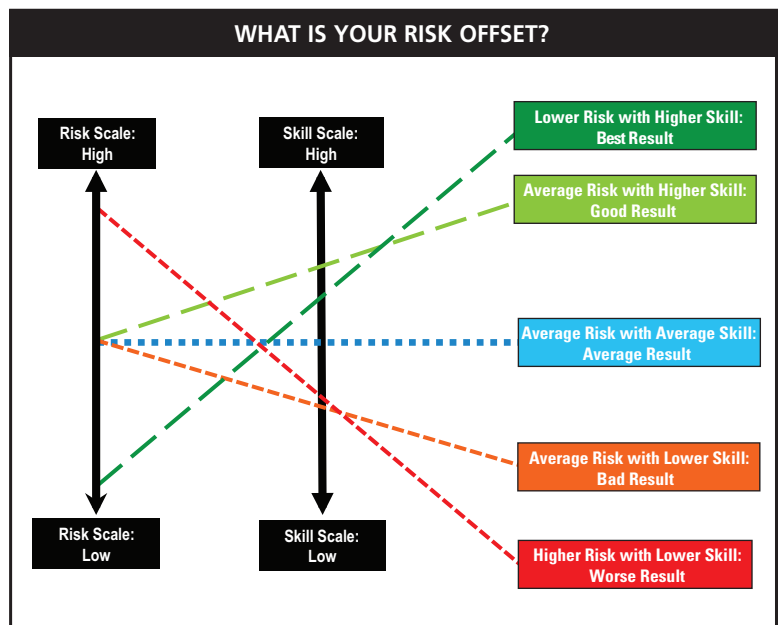

## SECTION 7. BASIC STREET STRATEGIES

**Introduction:** Thinking ahead to manage risks for a safe, enjoyable ride is part of being a good rider. Risk is always present, and much of it occurs around intersections and in curves. At intersections, others may not see you or yield the right of way, especially when they are turning left across your path from the opposite side of the intersection. In curves, it is often a matter of going too fast when entering a curve. It is important to search for possible collision traps and escape paths as part of your overall strategy.

Traffic situations can change quickly. You must be in full control of your motorcycle and have plenty of space to maneuver. You want to be able to respond smoothly ahead of time before you need to react to an emergency. You already know the value of mental preparation, riding gear, and the need to care for your motorcycle before you ride. Here are some ways to be active about your safety.

### POSITIONING

#### Lane Choice

If there is more than one lane, pick a lane where you do not have to change lanes often and can see ahead while being visible to others. Maintain a space cushion all around, and ride at the speed of traffic in your lane to help reduce potential conflicts. Consider shoulders and medians as possible escape paths.

On freeways with two lanes, keep right except to pass. On freeways with more than two lanes, avoid the right lane to reduce conflicts at entrance and exit points. When you change lanes, be sure someone does not want the same space you do.

#### Lane Position

As a motorcyclist, you can divide your lane into thirds: left, middle, and right. Your best lane position (LP) within a lane changes with conditions. Consider what is going on ahead, behind, and to the sides. Leaving room ahead for others helps you have space for yourself.

Change lane positions to avoid hazards, to avoid bad road conditions, and to see and be seen. Presentation is a term that means to use a lane position where others have a better chance to see you, especially as you approach a line of oncoming cars. Some examples of when to use a particular lane position include:

Use the left third (LP1):

1. Start (or default) position to see and be seen.
2. To see a car backing out of a driveway ahead on the right.
3. To keep drivers on your left from sharing your lane.
4. To see better when approaching a right-hand curve.
5. To increase your line of sight down the road.
6. To avoid doors opening from parked cars.
7. To be more visible at an intersection with a limited view to the right.
8. To avoid the dark strip of oil, debris, or manhole covers often found in the middle of a lane.

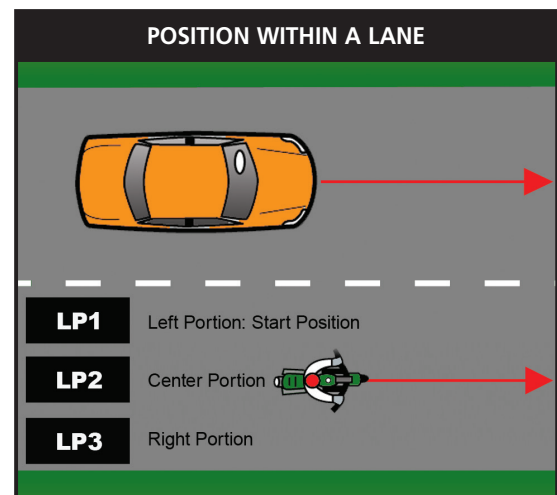
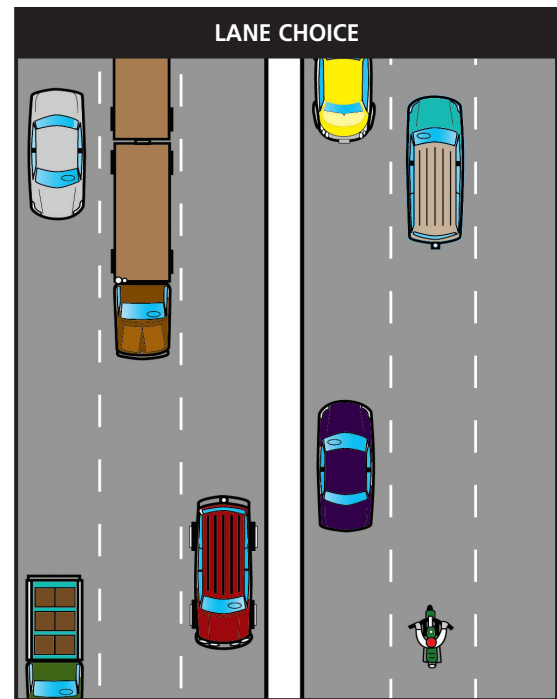

Use the middle third (LP2):

1. To help with hazards on both sides, such as cars parked on the right and traffic in the other lane.
2. To see and be seen at the crest of a hill.
3. To be visible at an intersection with a limited view on both sides.
4. To provide space on both sides of the lane for curves.

Use the right third (LP3):

1. To avoid windblast from an oncoming truck.
2. To see and be seen when there is a line of oncoming cars.
3. To see better when approaching a left-hand curve.
4. To be visible at an intersection with a limited view to the left.
5. To avoid the dark strip of oil often found in the middle of a lane.

## BEING VISIBLE

Use your eyes and mind to determine how and when to adjust position as situations unfold. Imagine a bird's eye view from high above to see how traffic conditions might affect you so you are ready to change lane position or speed.

It is your responsibility to make sure drivers have the best chance to see you. Distracted driving is on the rise, motorcycles are small and narrow, and drivers may not look for you. You must make yourself as visible as possible and at the same time, ride as if you are invisible. Even if a car driver seems to be looking you right in the eyes, do not assume they are really seeing you.

Besides using a good lane position, other ways to be seen include:

**Clothing:** Wear bright clothing and a light-colored helmet during the day. Use reflective material on your clothing and helmet at night.

**Headlight:** Be sure the headlight is on during the daytime; it may come on automatically. Use the high beam when legal for extra visibility, but don't blind other motorists.

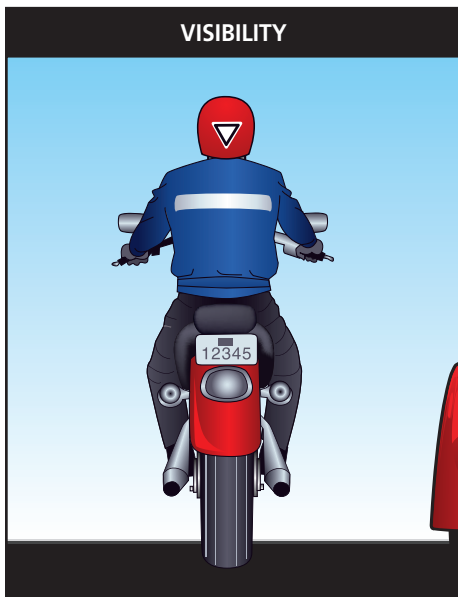

**Turn Signals:** Let others know what you plan to do. Then be sure to cancel your signal.

**Brake Light:** Flash the brake light before stopping (except for emergency stops) and as needed while waiting at stops to alert other motorists.

**Horn:** Use it to gain attention, but do not rely on it. Others may not be able to hear it.

**Add-ons:** Consider adding reflective material and more lights to your motorcycle.

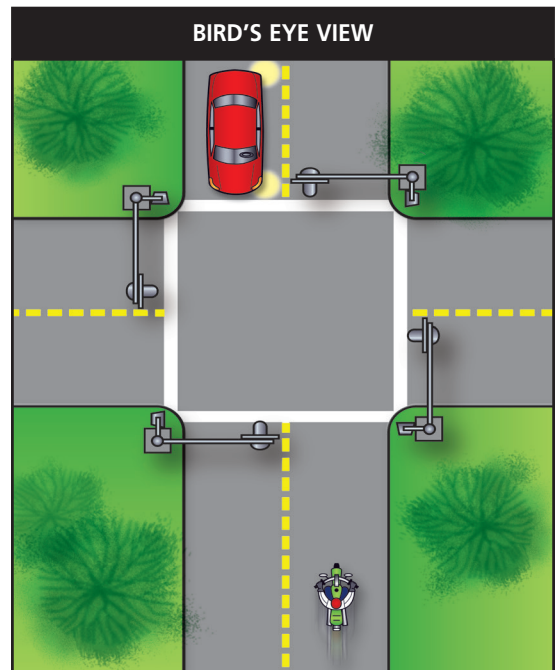

# SECTION 7. BASIC STREET STRATEGIES

## AN ACTIVE STRATEGY

### RiderRadar

RiderRadar is about looking ahead, to the sides, and behind in the rear view mirrors. Search far and near as well as from side-to-side. Factors in front make up most of the hazards that affect you. You want to be able to identify them as early as possible so you can respond well ahead of time and do not have to react to an emergency at the last possible moment.

Some locations are more hazardous than others and may be frequent crash locations for any roadway user. Examples include: an intersection with limited view, a tight curve, a slick surface, a road with no escape path, etc. More than three-fourths of the factors that affect a rider are between the 11 and 1 o'clock positions on a clock face, but maintain 360° awareness.

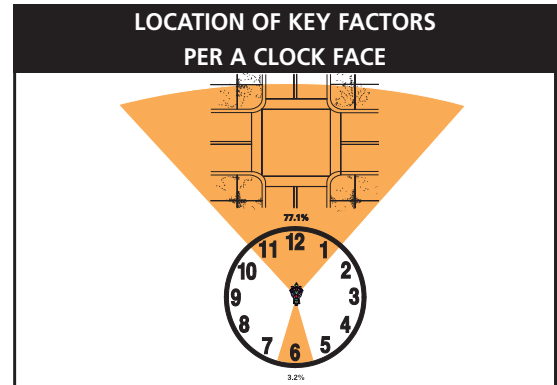

### Visual Lead Times and Distances

Using time and distance to your advantage requires you to know what is going on all around. Three visual lead times and distances make up RiderRadar:

- 2-second following time and distance
- 4-second urgent time and distance
- 12-second anticipation time and distance

These are mostly straight-ahead times and distances, but include possible paths to the sides. It may be surprising how far you travel, even at moderate speeds. If you multiply your miles-per-hour by 1.5, the result is approximately the number of feet you are traveling per second (e.g., at 30 mph, you are moving about 45 feet per second).

**2-second following time and distance:** This is a minimum when conditions are ideal and you are paying close attention ahead. It helps you avoid running into the vehicle in front of you if it slows suddenly. Less than perfect conditions require more time and space. Here is how to establish a two-second following time and distance:

Pick out a fixed point ahead, like a signpost or pavement marking. As the vehicle ahead passes the fixed object, count off "one-motorcycle-one, one-motorcycle-two" at normal talking pace. If you have not reached the fixed point by then, you have the minimum. Be sure not to count too fast.

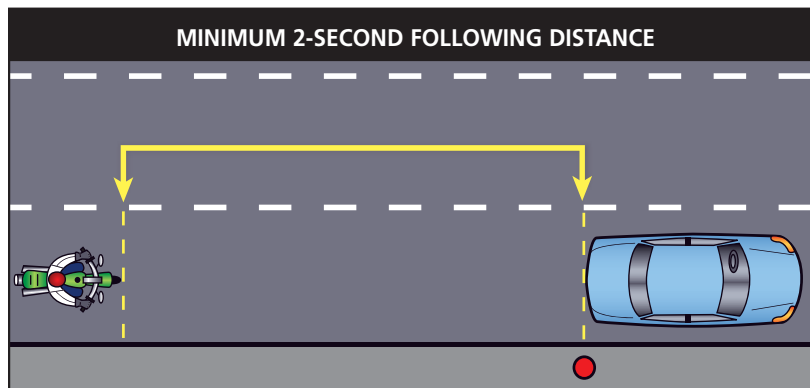

Having a greater following time and distance is better. This is especially important when you are a new rider, riding an unfamiliar motorcycle, riding in the rain, or if the person ahead can brake to a stop in a shorter distance than you. You want plenty of time to search, evaluate, and respond.

## SECTION 7. BASIC STREET STRATEGIES

**4-second urgent time and distance:** This helps you react properly to conditions, whether approaching an intersection, rounding a curve, or following another vehicle. You can avoid running into the vehicle in front of you if it hits something. You also can react to an object in the road that a vehicle straddles or steers around, such as a tire carcass, muffler, block of wood, or something that fell out of the back of a truck. With good braking skills, you can generally stop within the distance you would have traveled in four or five seconds. You may need all of that space to bring your motorcycle to a safe stop.

**12-second anticipation time and distance:** Evaluate areas it would take you that long to reach. The idea is to have a big picture of the entire environment and to be aware of the overall traffic flow. Consider single factors as well as multiple factors, like what drivers might do when they are interacting with each other. For example, a car that pulls out in front of another car may cause the second car to move into your path. Evaluating your path 12 seconds ahead gives you time to respond to changing conditions, which may help you avoid emergency situations.

Consider using greater times and distances. This is important when you are a new rider, riding an unfamiliar motorcycle, or riding in unfamiliar or hazardous areas. Having more time and distance gives you an extra safety margin.

### Total Stopping Distance

If you need to stop for a hazard, realize that braking distance is only one part of stopping. The three parts of total stopping distance are:

1. Perception distance
2. Reaction distance
3. Braking distance

Perception distance is how far you travel before you become aware of a hazard. You need full attention to know what is going on. The higher your speed, the more distance you travel while you perceive situations.

Reaction distance is the distance traveled from the time you become aware of a hazard until you apply the brakes. Again, higher speed equals more distance traveled.

Braking distance is the distance you travel after applying the brakes. Higher speed equals more braking distance traveled while you are using the controls.

If you are going 60 mph, you are moving about 90 feet per second. How many seconds might it take to perceive, react, and brake when a car pulls out in front of you? How many feet will you travel?

You can reduce risk by improving each part of total stopping distance. For perception, avoid being distracted and understand what is happening ahead. Do this by thinking *What if?* when potential traps are spotted. For reaction, cover the brake controls. Do this by moving the right hand over the front brake lever and right foot over the rear brake pedal when key factors are identified. For braking, keep braking actions sharp. Do this by practicing quick stops in a safe area so you know how your motorcycle will feel and respond.

Use your eyes and mind, your perception skills, and think *What If?* to be able respond smoothly instead of needing to instantly react.

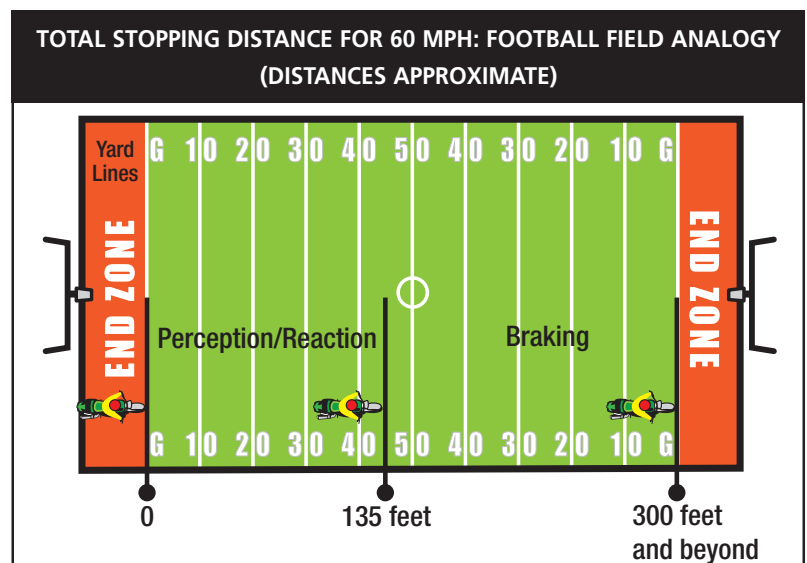

## SECTION 7. BASIC STREET STRATEGIES

### MENTAL PROCESSING

While having good physical skill is important, safe riding depends as much on the mental skills of awareness and judgment as it does on the being able to maneuver the motorcycle. A good strategy to use is *SEE*. *SEE* stands for *Search*, *Evaluate*, and *Execute*. *Search* and *Evaluate* relate to the eyes-and-mind part, and *Execute* refers to the hands-and-feet part.

**Search:** *Search* means to scan far and near and side-to-side. It includes:

1. *360° awareness*: imagine hovering high over your position so you can see all the factors that affect you.
2. Checking the mirrors, blind spots, and instruments.
3. Using your eyes to take in all that is important, and your mind to sort out things.
4. Having an escape path: a way out, and include open areas to move into if braking alone is not enough to avoid a crash.

Your eyes should be busy and your mind active. Do not look at (or target-fixate) on any one object for more than a split second. Keep your eyes moving – far and near, side-to-side, including the instrument display and mirror and blind spot checks. Search in four categories:

1. Traffic controls and roadway design features (lights, signs, medians, etc.).
2. Roadway users.
3. Road and surface conditions.
4. Escape paths, in front and to each side.

These categories help you organize a complex environment so you can identify key risk factors at any given moment.

**Evaluate:** To evaluate means to think about what could happen. It includes:

1. Figuring out how hazards and factors are combining to create a trap.
2. Predicting the worst to get the best results.
3. Thinking beyond the moment about options.
4. Being ready to change a decision.
5. Planning how to respond to potential traps.
6. Keeping a margin of safety.
7. Thinking *What If?*

Ride so the mistakes of others do not affect you. For moving hazards, separate yourself from them by making speed or position changes to meet hazards at different points in time. As an example, avoid meeting a large vehicle on a narrow bridge. For fixed hazards, adjust your position on the road. You do not want to ride into a trap where there is no escape.

**Execute:** This means to use smooth and well-timed actions. It includes the three action steps of:

1. Adjusting speed, which means to slow down or speed up to separate hazards.
2. Adjusting position, which means to pick a better lane or better spot within a lane.
3. Communicating intentions, which means to use turn signals, brake light, or horn.

Using *SEE* well as a car driver is a good start for processing information as a motorcyclist. A motorcycle rider must be a good decision-maker to minimize risk, and this includes choosing not to ride if circumstances or conditions such as storms, heavy rain, lightning, flash flooding, heavy fog, dust storms, etc., make it unsafe to ride. If conditions deteriorate while you are riding, stop in a safe place and wait it out.

### ESCAPE PATHS

Not having sufficient safety margins invites risk. Riding at any speed requires an adequate space cushion to brake and/or swerve. You must have time and space to maneuver.

Avoid target fixation so you do not crash into what you are staring at. Instead, look for your escape-path options. You want to have an escape path that is open and allows you to avoid a collision. An escape path can be in front of you, to the right, or to the left. Escape paths can be within your lane, in the next lane over, on a shoulder or median, or even off the road if conditions permit.

It is best to have more than one escape path open so you don't get trapped. If your escape path requires a hard swerve, be sure to separate the swerve from any braking. Keep in mind a motorcycle does not need the same width as a car.

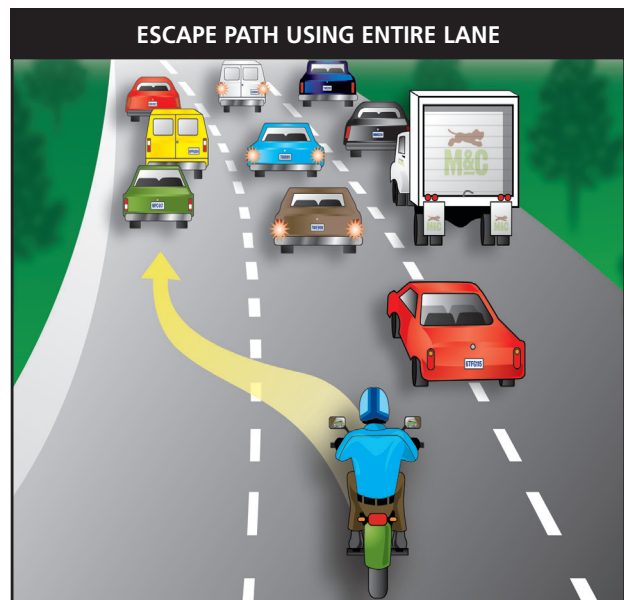
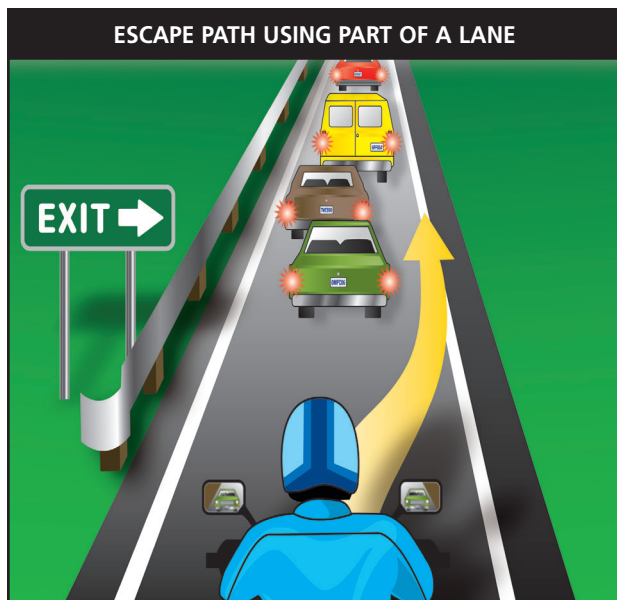

## SECTION 8. STRATEGIES FOR COMMON RIDING SITUATIONS

**Introduction:** Crashes are caused by an interaction of factors, or a combination of hazards. You can manage risk by being able to Search-Evaluate-Execute (SEE) well. Below are common riding situations and ways to help you be a better, safer rider.

### INTERSECTIONS

The greatest potential for a conflict between you and other traffic is at intersections. It is important to evaluate what might happen several seconds before you reach an intersection. Roundabouts, driveways, alleys, medians with openings that allow left turns across lanes, pedestrian crosswalks, and railroad crossings should all be considered intersections.

You want to have 360° awareness. Be aware of traffic ahead, behind, and on the left and right. Remember to use *Presentation*, which means to use a lane position where others are best able to see you.

Notice when others may not be able to see you. Be aware of *blind spots* caused by stationary objects such as trees, light poles, parked cars, fencing, etc. Even if you are in view, drivers could still turn in front of you.

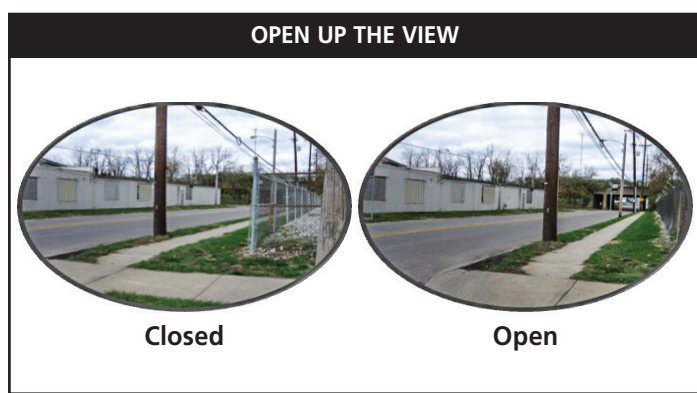

When you are approaching an intersection, have an escape path in case someone makes a mistake. Be prepared to accelerate, stop, or swerve. Remember to have a four-second urgent distance open. Identify traps and plan escape paths early.

At some intersections, it may be necessary to stop more than once, especially to *Open Up the View* the best you can. This means to use a position to see and be seen in both directions without interfering with cross traffic or pedestrians. Before pulling out, make your final check in the direction of the closest potential hazards.

When waiting at a red light, remain in 1st gear and use the rear brake pedal or front brake lever to keep the brake light on. You may want to shift to neutral if the wait will be long and traffic is stopped behind you. Shifting to neutral has the same effect as keeping the clutch lever fully squeezed. Check the mirrors often, and be in 1st gear and flash your brake light if someone approaches from behind. Have an escape path ready. After the traffic light changes, wait a second or two and thoroughly check cross traffic before moving out, as some drivers run through red lights.

Some intersections have traffic-actuated lights that use sensors in the road surface to detect traffic. Sometimes they do not detect a motorcycle. Try to stop over the sensors if they are visible.

If you are turning from a stop, select a lane position that allows you to see traffic. If the turn is tight, it may help to turn the handlebars and lean the motorcycle slightly in the direction of the turn before starting out. You can also position yourself at a slight angle. Manage the clutch lever and throttle so you do not accelerate too fast or turn too wide.

### BETWEEN INTERSECTIONS

The roadway between intersections also can be hazardous. Be sure to keep a space cushion all around and have an escape path open. Have plenty of following distance. If the escape path directly in front is not enough, the next best path is usually on the right.

Watch for vehicles pulling out of parking areas or backing out of driveways. Notice parked cars where a car door could open in your path. Search for people or animals that could dart out in front of you. Look for pedestrians, bicycles, and other vehicles that could affect escape paths.

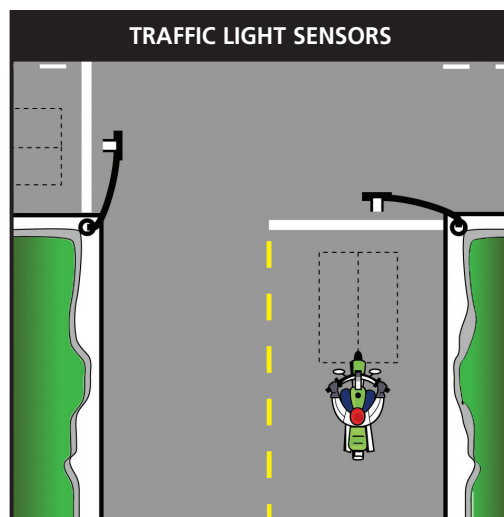

## SECTION 8. STRATEGIES FOR COMMON RIDING SITUATIONS

### BLIND SPOTS

Blind spots are areas that make it impossible for you to see others or for others to see you. You have blind spots beside and behind you; others have blind spots beside and behind them, and the roadway has its own blind spot areas that block everyone's view.

You have blind spots behind and beside you that you cannot see in your mirrors. Even if your mirrors provide good coverage to the rear, check the blind spots with a head check (a glance over your shoulder) whenever you change lanes, pass a vehicle, pull into traffic, or adjust lane position.

You must avoid riding in the blind spots of others. Drivers may not see you because of doorposts or passengers. Their mirrors do not eliminate blind spots either.

Blind spots also refer to the areas ahead where your view is blocked by vehicles, trees, or buildings. An intersection with a limited view is like one large blind spot. Blind spots at or between intersections can hide cars, bicycles, and pedestrians.

The No-Zone refers to blind spots around large trucks. These blind spots are on the sides, in the rear, and in the front. You should avoid the No-Zone. Never cross behind a truck, bus, or larger vehicle that is backing up. When passing or being passed at higher speeds, be ready for air turbulence that could affect you. When passing, be sure to have a lot of space. At intersections, the right-side blind spot of a truck or bus is doubly dangerous because of wide turns.

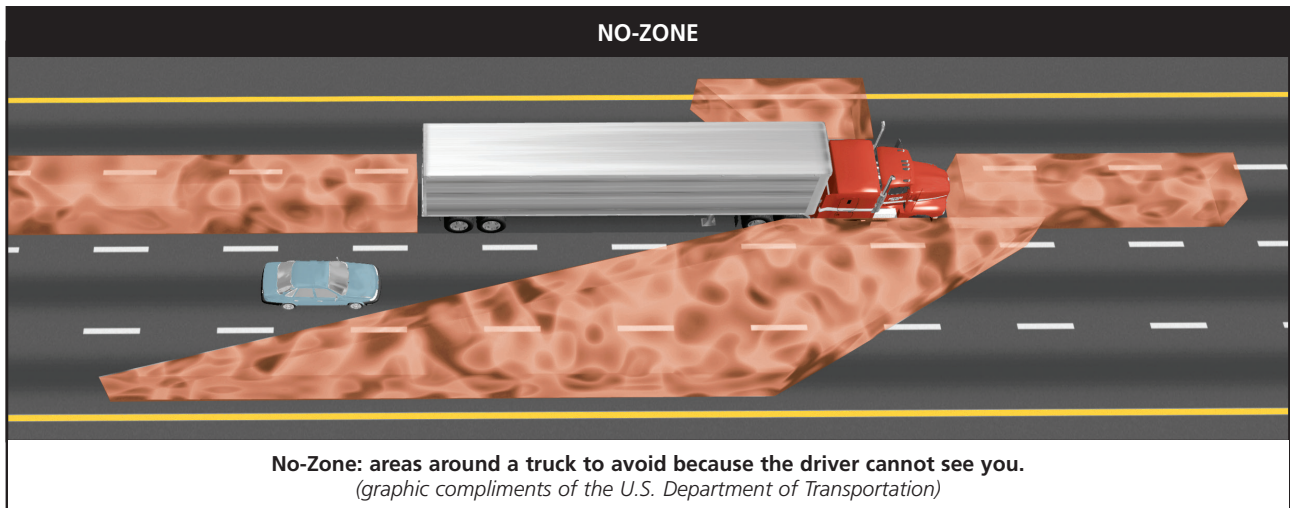
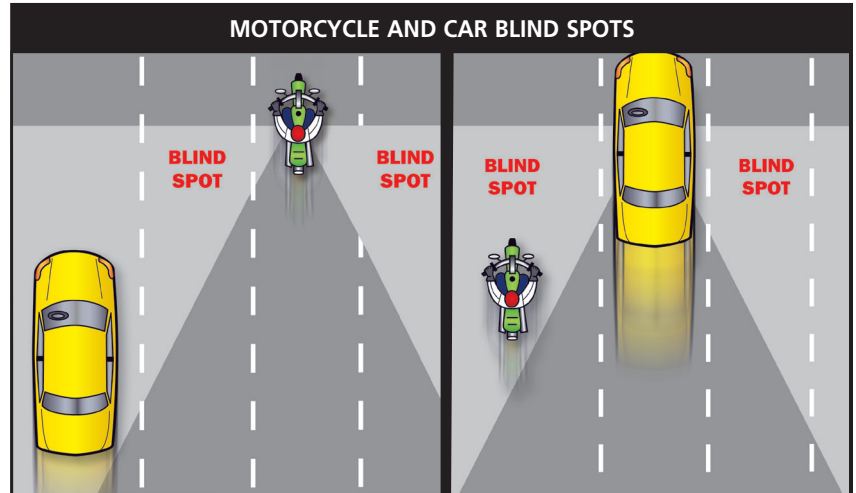

## SECTION 8. STRATEGIES FOR COMMON RIDING SITUATIONS

### LANE CHANGES

A lane change procedure for a motorcycle is similar to a lane change for a car. Check to see the space you want remains open. Remember convex mirrors make objects look farther away than they are. Use a head check to see what is not seen in your mirrors. Signal in advance and cancel the signal when in the new lane. Sometimes using a signal early will encourage a driver behind to give you more space.

### FREEWAY MERGING AND EXITING

Merging onto a freeway is similar to making a lane change. Watch for traffic behind you that will also enter the freeway. If possible, try to match the speed of the traffic flow on the freeway before you reach the end of the on-ramp or acceleration lane. Have an escape path, which could be the shoulder area. When exiting a freeway, maintain speed until you are out of the traffic flow and in the deceleration lane. Be extra cautious when your merging area or your exit area is the same area that other traffic uses to exit or enter a freeway. Use a good lane position so you can see and be seen.

### CURVES

Riding through curves can be a lot of fun. But crash studies show running off the road accounts for many crashes. Do not push yourself by getting too bold. Use good judgment to stay well within your limits. Be sure to have a good entry speed and maintain your safety margins with plenty of good risk offset.

There are three general curve types:

1. Constant radius, which has the same curvature throughout.
2. Increasing radius, which has the curve open up.
3. Decreasing radius, which has the curve close up and become progressively tighter.

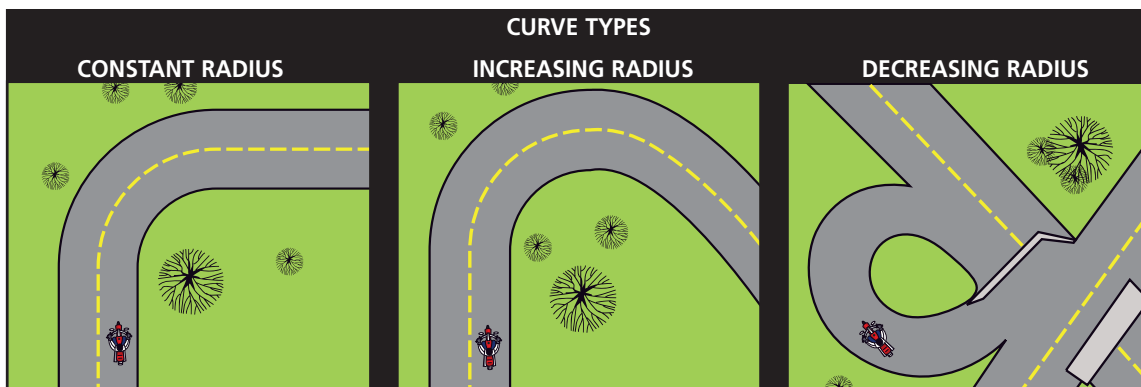

There are three general curve parts:

1. Entry, which is the first part of the curve.
2. Apex, which is the middle or sharpest point in your path around the curve.
3. Exit, which is the last part of the curve.

There are three general lane positions:

1. Outside, which is farthest away from the center line in a left-hand curve and nearest the center line in a right-hand curve.
2. Middle, which is the center of the lane.
3. Inside, which is nearest the center line in left-hand curve and farthest from the center line in a right-hand curve.

## SECTION 8. STRATEGIES FOR COMMON RIDING SITUATIONS

Using three curve parts and three lane positions means you have 27 options. To illustrate, you could use a general strategy of middle-middle-middle: middle on entry, middle at the apex, and middle at the exit, as this provides space on both sides within your lane throughout the curve. Or you could use a performance-type strategy of outside-inside-outside that reduces the lean required and allows you to see farther through the curve, but gets you closer to the center line and the shoulder. For any strategy you use, having a good entry speed is crucial so you do not have to make any major speed or lane position adjustments in the curve.

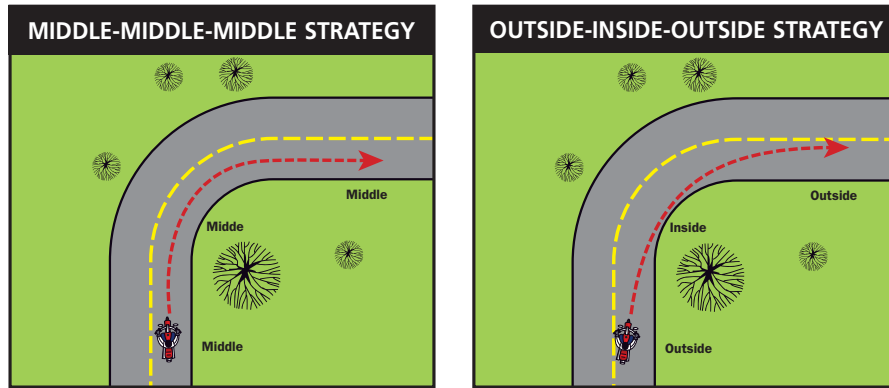

Because there are many variables when negotiating a curve, you have many choices. Here are some tips:

### Search:

1. Observe roadway warning signs that inform you of curve direction and sharpness. Heed the posted speed.
2. Look as far ahead as you can to see what is beyond the curve and whether there are more curves or elevation changes. Sometimes tree lines can help you determine what is coming up.
3. If you cannot see the exit, predict the curve radius tightens up and hold entry speed farther into the curve.
4. Consider the potential for oncoming traffic.
5. Consider factors that could affect speed and lane position.
6. Note road and surface conditions. There may be gravel or oil on the road, and the surface near the shoulder may be cracked, broken, or uneven.
7. Notice if the road is crowned (higher in the middle) or off-camber (higher on one side). These roads can affect cornering clearance.
8. For very sharp curves, search for approaching vehicles that could be over the center line.

### Evaluate:

1. Predict the worst to get the best results. For instance, imagine an obstacle is blocking your lane or there is gravel on the surface just beyond where you can see. Set your entry speed accordingly.
2. Choose an entry speed and select a gear to provide the most options to adjust for conditions. You do not want to suddenly change gears or make abrupt speed changes in a curve. Have a smooth transition from approach speed to entry speed.
3. Consider a middle-middle-middle lane position that provides space on both sides of the lane.
4. When using an outside-inside-outside strategy, consider a late turn-in with a delayed apex to avoid running wide.
5. Have an escape path throughout the curve.
6. Be able to stop in the distance you can see.

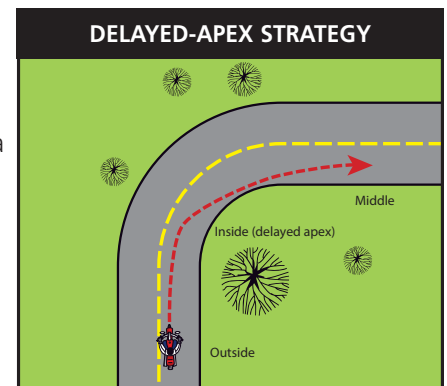

## SECTION 8. STRATEGIES FOR COMMON RIDING SITUATIONS

### Execute:

1. Smoothly and precisely use the controls.
2. In left-hand curves, avoid getting too close to the center line so you are not leaning over it.
3. Avoid the need to brake hard in a curve, as the motorcycle will typically want to stand up and take a wider path.
4. If you need to lean a lot in a curve, place the balls of your feet on the footrests to keep your boots from touching the ground.
5. If you find yourself running wide in a turn, look farther through the turn and press more on the inside handgrip to increase lean. It helps to move your upper body to the inside of the turn so the motorcycle will stay more upright and not scrape parts.

### General:

1. Stay in your comfort zone and do not push yourself because of drivers or riders behind you.
2. If you catch yourself pushing your limit or are making even minor errors, slow down. Listen to your safety voice.
3. Ride well within your skill limits and the tires' traction limits (have a traction reserve).
4. If the terrain is hilly, use a lower gear so you have better throttle response. You can use the throttle to fine-tune your speed and lane position, especially if you are in the proper gear.
5. Watch your speed in downhill curves. It may help to use a low gear to permit engine braking.
6. When riding through lots of curves (like on mountainous roadways), be sure to breathe well to help you stay alert.
7. For multiple curves, keep your speed under control and adjust lane position to keep safety margins.

A recommended approach for all curves is to use a middle-middle-middle strategy along with good judgment to adjust to conditions as needed. Remember Search-Setup-Smooth.

### LIMITED-SPACE MANEUVERS

Maneuvering in a limited space can be challenging. Making a tight, sharp turn or U-turn is an important skill to master. It helps you in parking lots, when turning around on the street, and in making a tight turn from a stop.

Here are some considerations where space is limited. Find the combination of techniques that is best for you. These include:

1. Using a very low speed and sharp handlebar turn.
2. Using the friction zone and throttle in combination with the rear brake to control speed.
3. Using a counterweight method. This permits more motorcycle lean for a tighter turning radius. Putting more pressure on the outside footrest can help. Also, you can move off the seat toward the outside of the turn. Turn your head to get a good sight picture of where you want to go.
4. For a tight turn from a stop, turn the handlebars before moving out.
5. Know that a sudden increase in speed will straighten up the motorcycle.
6. As needed, touch a foot to the ground (dab).
7. If space is very limited, you can power-walk or stop and back up before finishing the turn.



## SECTION 8. STRATEGIES FOR COMMON RIDING SITUATIONS

### STARTING ON A HILL

A special procedure is needed to start out on an uphill grade. A good way is to apply one of the brakes to prevent rolling backwards. If you need to keep both feet on the ground, use the front brake lever while easing out the clutch lever until you can apply some throttle. Use the friction zone to hold your position. It is a good idea to practice the procedure in a parking lot or on a lightly traveled street before needing to do it with traffic behind you.

### OBSTACLES

Good searching skills help you avoid potholes, speed bumps, and stationary objects. If something cannot be avoided (like uneven railroad tracks), there are some specific actions you can take.

Here are some tips to cross over an obstacle or bumps:

1. Slow as much as conditions permit.
2. Approach at a 90-degree angle if possible.
3. Avoid fixating on the obstacle – look ahead to where you want to go.
4. Rise off the seat with your knees bent and against the tank.
5. Use your legs as shock absorbers.
6. Hold both handgrips firmly and do not cover the brake lever or clutch lever.
7. Just before contact, shift your weight to the rear and blip the throttle (quick roll-on) to extend the front forks.
8. Upon contact, abruptly roll off the throttle so the rear wheel is not under power when it crosses over the obstacle.
9. Sit down when the motorcycle is stable.
10. Continue to SEE.

### PARKING

Parking a motorcycle includes some special actions.

Here are some tips for parking:

1. If parking in a parallel parking space next to a curb, position the motorcycle at an angle with the rear wheel to the curb. This will allow you to pull out more easily with a better view. Position it to be visible to others. (Note: Some cities have laws that require motorcycles to park parallel to the curb.)
2. If using the side stand, turn the handlebars left to the full lock position for more stability.
3. Lock the forks and take the key.
4. Use a quality lock and chain and secure it through the frame.
5. Consider adding a security alarm.
6. Use a flat, rigid object under the side stand, like a flattened soda can or a motorcycle side stand pad, to keep it from sinking into soft surfaces and causing the motorcycle to fall.
7. Be sure the stand provides stability on a sloped surface.
8. Leave the motorcycle in first gear so it is less likely to roll.
9. Park in a secure area with lots of lighting.
10. Use a non-branded motorcycle cover.

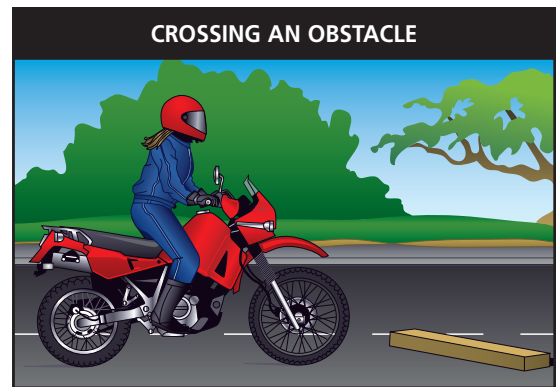

## SECTION 8. STRATEGIES FOR COMMON RIDING SITUATIONS

### ROAD FURNITURE

Road furniture refers to all roadside objects. Examples include road signs, guideposts, safety barriers, light and utility poles, mail boxes, bus shelters, fire hydrants, etc. Make sure you include road furniture as part of your search-and-evaluate strategy as objects may affect your possible escape paths.

### PASSING

The passing procedure for a motorcycle is similar to a passing procedure for a car. Avoid passing more than one vehicle at a time. The driver in front of the line may turn left, and any driver could pull out to pass. To complete a pass:

1. Keep a good following distance and move to the left third of the lane.
2. Have a safe passing gap ahead.
3. Check your mirrors and blind spot (with a head check) and turn on your signal.
4. Change lanes and accelerate.
5. Cancel your signal.
6. Select a lane position that gives you space from the vehicle you are passing.
7. When past the vehicle, check your mirror and blind spot (with a head check), signal, and return to your lane.
8. Cancel your signal.
9. Continue to SEE.

### TAILGATERS

Drivers who tailgate pose a hazard. Do not let such a driver keep you from using RiderRadar. You should increase your distance from vehicles ahead of you so you have more time and space to stop. Then the tailgating driver will not need to make a quick stop because you won't have to make a quick stop.

Some other options to respond to a tailgating driver are:

- Use one of the brake controls to flash the brake light.
- Change lanes.
- Turn off the road.

If the driver behind you remains close, keep escape paths open to the left and right sides. This will help keep you from being trapped.

### NIGHT RIDING

Riding at night, including at dusk and dawn or in other limited visibility conditions such as fog or dust, reduces what you can see and what others can see.

1. Wear bright, reflective materials.
2. Use your high beam unless oncoming traffic is approaching.
3. Use the lights of other vehicles to help you see what is ahead.
4. Watch for taillights that bounce because it could indicate a road surface hazard.
5. Flash your brake light when slowing and when waiting at intersections.
6. Add lighting to your motorcycle.

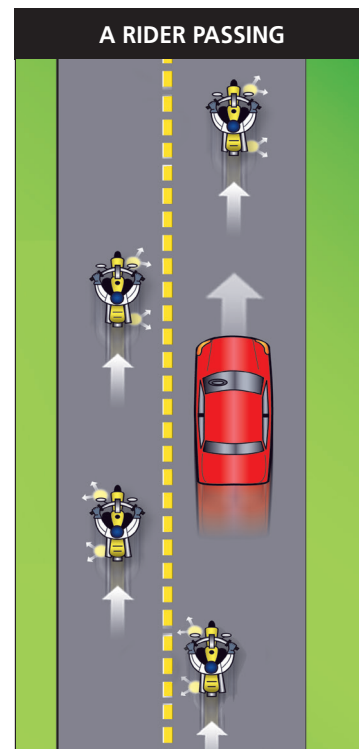

## SECTION 8. STRATEGIES FOR COMMON RIDING SITUATIONS

Be sure your eye protection is free of scratches and smudges. Do not use tinted lenses at night.

You do not want to override the headlight. This happens when your total stopping distance exceeds the distance your light beam shows. Keep in mind hazards can enter your path from the sides. Slow down so you are able to stop in the distance you can see.

### GROUP RIDING

You want to have good basic skills before riding with others. Riding with others involves special considerations because there is a lot more to think about than when riding alone.

Be sure to *ride your own ride* and not just do what the rider in front or behind does. Avoid group pressure to ride beyond your skill or comfort level. You want to keep your attention on your personal safety margins.

Here are some tips for group riding:

1. Arrive ready with plenty of gasoline, and check with the group leader for details about the ride.
2. Learn common group riding signals.
3. Use a staggered formation unless there is the need for single-file riding.
4. Avoid side-by-side riding as the time and space safety margin is reduced.
5. Use a single-file formation with at least a 2-second following distance for curves and other situations that require more maneuvering room and an increased safety margin, like poor surface conditions or limited visibility conditions.
6. Avoid engine braking, and use the brake light whenever slowing.
7. Check riders ahead and behind often.
8. Avoid target fixation (looking in one spot for more than a second), especially on other riders you are with, so you can keep an active visual search pattern.
9. When you pass, do so as an individual rider.
10. If you get separated from the group, ride your own ride to the next pre-determined stop.
11. Be predictable, and follow group protocol as long as it is safe.
12. Use extra caution in right-hand curves, especially when the end of the curve is not in view.

There is also an MSF classroom-only program, Share the Adventure – *Group Riding*, that provides details and tips about riding in a group. Information can be found inside the back cover.

#### Check the space as appropriate:

\_\_\_\_\_ I accept the risks of and commitment to managing the risks associated with riding a motorcycle in a complex traffic and roadway environment.

## SECTION 9. BASICS FOR EMERGENCIES

**Introduction:** It is better to respond early to a situation than to react at the last second in an emergency. We live in an imperfect world and people make mistakes. While avoiding an emergency situation in the first place is a goal, it is also a wise idea to have good crash-avoidance skills in case you need them.

### BRAKING SYSTEMS

Motorcycles typically have a front brake lever to apply the front brake and a rear brake pedal to apply the rear brake. Check your motorcycle owner's manual to see if your motorcycle has any of the following specialized braking systems:

- Combined or linked brakes: Braking force is applied to both wheels when either control is used. The degree of braking force varies by design.
- Integrated brakes: When the rear brake pedal is pressed, some braking force is applied to the front brake.
- Anti-lock braking system (ABS): Keeps the wheels from locking (skidding) when too much brake pressure is applied.

### EMERGENCY STOP IN A STRAIGHT LINE

Making an emergency stop is an important skill. Practice often in a safe area. Use lower speeds and less-than-maximum pressure on the controls when developing your skill. Start your practice at low speeds.

The best way to achieve the shortest braking distance is to use the controls in a way that produces maximum braking pressure at the front and rear brakes simultaneously without skidding either wheel. Squeeze the clutch lever, and use the brake controls at the same time. Keep your body centered and look ahead. Squeeze your legs against the gas tank to keep from sliding forward on the seat. Adjust your braking pressure as the weight of the motorcycle transfers forward by using less pressure on the rear brake pedal and more pressure on the front brake lever.

The ability to use the brakes fully without producing a skid is called *threshold braking*. This kind of braking takes a special feel for the controls. It is important to squeeze, not grab, the front brake lever and press, not jab, the rear brake pedal. Remember that surface conditions may affect how much pressure you can use, and you want to be ready to adjust the pressure for best results.

### EMERGENCY STOP IN A CURVE

Making an emergency stop in a curve requires effective use of available traction for both leaning and braking. Some traction is used for cornering, so you should generally use less brake pressure in a curve than when braking in a straight line. Basically, you have two choices. One is to straighten up first and make a quick stop in a straight line. The other is to apply some brake pressure while leaned and increase brake pressure as the motorcycle straightens up.

If you decide to straighten up first, there must be enough space to complete the stop. If road and traffic conditions permit, straighten the motorcycle first and square the handlebars (center the steering) before applying the brakes.

If you use brake pressure while the motorcycle is leaned, apply the brakes with progressive smoothness. As the lean angle is reduced, apply more brake pressure. It is best to have the motorcycle straight up, with the handlebars square, at the end of a stop.

### FRONT TIRE SKID

Too much front brake pressure can produce a skid. To keep from skidding, use the front brake lever with a progressive squeeze. If the front brake lever is quickly squeezed before weight transfers forward, the wheel can stop turning and the front tire will skid. The result is a sudden loss of control. If a front tire skid occurs, you must release the front brake lever to get the front wheel rolling again. Then apply the brake again if needed. Improper use of the front brake could cause a fall.

### REAR TIRE SKID

When slowing quickly, weight increases on the front tire and lightens on the rear tire. You have to use less pressure so the rear tire does not skid.

A rear tire skid can be straight or it can cause the back of the motorcycle to skid sideways. If the back moves sideways, keep

## SECTION 9. BASICS FOR EMERGENCIES

pressure on the rear brake pedal so the wheel continues to skid, and maintain balance to stay upright. Keep your head and eyes up. Your path of travel will remain in the direction you were going when the skid began.

If the rear wheel is nearly in line with the front wheel, you can release the rear brake pedal and then reapply it as needed. Do not release the rear brake pedal when the rear wheel is not in line with the front wheel. If the rear wheel stops skidding and starts to roll, the motorcycle will quickly straighten and you can be thrown off in front of the motorcycle. This is called a high-side fall or crash.

### SWERVING

Swerving refers to an emergency procedure where you change direction quickly to the right or left. There must be good traction and a clear path. Swerving skillfully requires practice.

Do not brake while making an aggressive swerve. Any braking, even engine braking, while making a swerve may cause the tires to lose traction. If you can slow before swerving, do so and release the brakes before starting the swerve.

#### Swerving on a Straight Road

Your initial press should be firm enough to cause the motorcycle to lean quickly. Allow the motorcycle to lean independently beneath you. Keep your torso upright, knees against the tank, feet on the footrests, and look toward your clear path. Do not look at what you are trying to miss, and have a clear path for the swerve back.

#### Swerving in a Curve

Swerving in a curve requires similar steering inputs to swerving on a straight road, but additional traction must be available. If the swerve is in the opposite direction of the motorcycle's lean, a much greater lean angle is needed to recover after the initial swerve.

### THE BRAKE OR SWERVE DECISION

The decision whether to brake first or swerve first in an emergency is critical. You need excellent Search skills so you can effectively Evaluate and use your escape options. Keep in mind an escape option can change quickly if the hazard is moving. For example, a car pulling out in front of you could continue in its path or it could stop right in front of you.

If you brake without enough distance to stop, you would crash at a reduced speed. If you swerve without slowing and do not have enough space to avoid the hazard, you would crash at your original speed.

Here are examples that require a quick decision and action.

When going straight: A car backs out of a driveway. Would you brake or swerve? Would you do the same for a child chasing a ball into the street?

When in a curve: You notice an obstacle is in your intended path. Would you have enough space to straighten and then brake before continuing around it? If you brake while leaned over, is there enough space to swerve and recover?

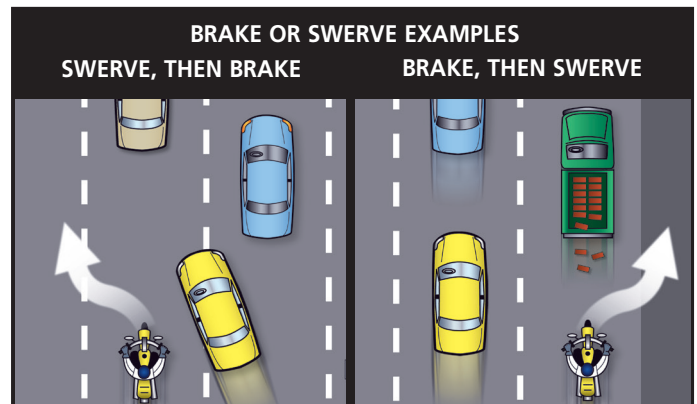
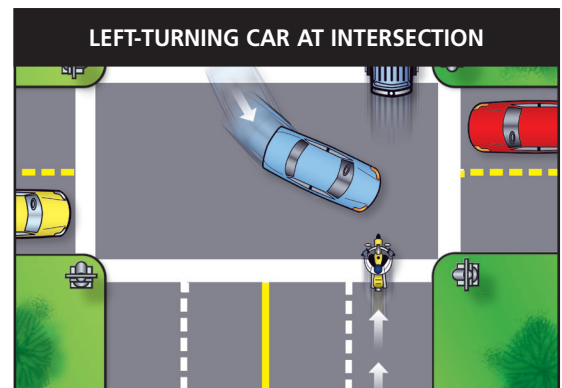

## SECTION 10. SPECIAL RIDING SITUATIONS

**Introduction:** There are tactics you can use to handle special situations. You must have a mental strategy as well as physical skills to respond to the assortment of variables.

### ROAD SURFACES

**Rain-slick surface:** The surface is most slick during the first few minutes of rain because oil and dirt mix with the water. It may be best to stop in a safe area and wait out the situation. If you do ride, reduce speed, minimize lean, and increase your space cushion. Metal covers, bridge gratings, train tracks, painted or taped lines, leaves, and wood can be very slick when wet. When you ride in the rain, use the tire tracks left by cars to help prevent hydroplaning. Hydroplaning occurs when water builds up under the tire contact patch and results in loss of traction. Maintaining proper tire pressure will help keep the grooves in your tread open and able to channel water away for better traction.

**Worn pavement:** Depressions can form in areas of heavy traffic. Deep ruts or pavement separation can make handling your motorcycle difficult and may even cause damage if you hit them hard. Rain builds up in these areas and increases the chance of hydroplaning. Avoid depressions and ruts when possible. Watch for uneven pavement (like edge traps) especially around road construction.

**Loose surfaces and debris:** Be aware of sand, gravel, rocks, and trash. The same is true for liquids such as fuel, oil, and engine coolant. Look out for shiny or damp pavement. Watch for items that might cause tire damage such as nails or sharp metal objects. Use a good lane position, especially in curves, to give yourself time and space to adjust your path. Avoid following vehicles such as trucks or trailers that are hauling debris as items could come loose and fall into your path.

**Crack sealant and tar strips:** These can be slick, especially in wet or hot weather. Notice them early and adjust lane position. Avoid too much lean.

**Ice or snow patches and mud, moss, and algae:** These areas can be very slick. Identify them early and reduce speed. When crossing slick patches, you may want to keep the clutch lever squeezed and avoid leaning. Use your feet as outriggers as needed, remembering they may also slip. Brake use must be gentle.

**Crowned and off-camber roads:** A crowned road is higher in the middle than the sides to drain water. Use caution in left-hand curves because ground clearance may be affected. An off-camber road has its entire surface tilted toward one side. When stopping on an off-camber road surface, you may need to reach farther to touch the ground.

**Rain grooves and grated bridge decks:** These cause the tires to feel loose, but they pose no serious threat. Keep steering relaxed and avoid quick actions.

**Bumps, cracks, and railroad tracks:** These are like obstacles, so cross them at close to a 90-degree angle. Keep speed under control and maintain momentum. Rise off the seat and keep your weight evenly distributed. For angled railroad tracks, it is usually safe to ride straight across them. For tracks or road seams that run in the same direction as your path, move far enough away so you can steer to cross them at 45 degrees or more.

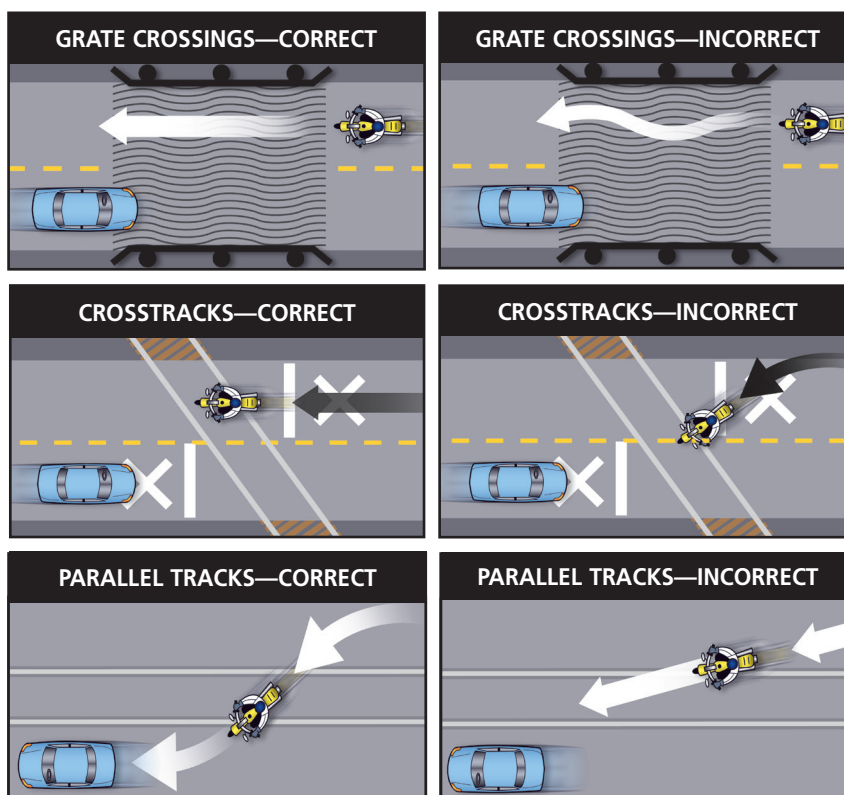

### CARRYING PASSENGERS OR CARGO

You should be a skilled rider before you carry a passenger or cargo because it affects the way your motorcycle handles. Starting from a stop may be more difficult, and it may take longer to get up to speed. More time may be needed for passing. More brake pressure may be needed for stopping. See the owner's manual for proper suspension settings and tire pressure.

Here are some tips for when you carry a passenger:

1. The motorcycle should be equipped to carry a passenger, which includes proper seating behind the operator and passenger footrests. A passenger should be tall enough to reach the footrests, strong enough to hold onto the operator or passenger hand-holds, and mature enough to understand the risks and responsibilities.
2. Be sure the passenger wears all of the proper protective gear.
3. While the passenger mounts and dismounts, keep both feet on the ground and the front brake lever applied.
4. Be extra smooth, and go easy on lean angles.
5. Have the passenger follow these rules:
  - a. Hold your waist or hips or use the passenger hand-holds.
  - b. Keep feet on their footrests at all times, including when stopped.
  - c. Keep hands and feet away from hot or moving parts.
  - d. In turns and curves, look over your shoulder in the direction of the turn or curve.
  - e. Avoid leaning too much or turning around.
  - f. When crossing an obstacle, rise slightly off the seat.

Practice your basic skills with the passenger so your skills are ready. Make a few quick stops so you both know how it will feel. You want to be aware of how the motorcycle handles differently.

Here are some tips for when you carry cargo:

1. Do not exceed the motorcycle's load limit as specified in the motorcycle owner's manual.
2. Keep items low and close to the center of the motorcycle.
3. Keep items evenly balanced from side-to-side.
4. If you use a tank bag, be sure it does not interfere with handlebar movement.
5. If you use a backpack, carry light items that are not sharp and ensure it doesn't affect your ability to control the motorcycle.
6. Do not overload the saddlebags or tank bag.
7. Carrying weight on the rear will lighten the front end and may affect handling.
8. Never strap items to the handlebars, front forks, or front fender. Even if handlebar and suspension movement are not limited, the extra weight can affect steering.
9. Do not block lights or moving parts, and keep items away from mufflers.
10. Be sure the cargo is secure. Use accessory racks and luggage designed for your motorcycle. Be sure there are no loose items to blow around or get caught in the wheels. Use web straps, bungee cords, cargo nets, or similar fasteners. If you use bungee cords or elastic nets, be sure the ends are secure and



## SECTION 10. SPECIAL RIDING SITUATIONS

that a stretched cord does not snap back and injure you.

### TOURING

Touring refers to traveling around from place to place, usually over long distances and sometimes for several days. Such riding should be limited until a rider has gained experience so there is an understanding of the physical endurance and mental attention span required for touring. Proper preparation and planning is important. Consider potential weather conditions. Plan plenty of stops to avoid fatigue and to maintain hydration and nutritional needs. Have clothing that lets you dress in layers and pack the right tools to make emergency repairs.

Carry extra food and fluids if you will be in remote areas, and consider the lack of cell phone coverage. Emergency services may be some distance away. Let someone know your plans, especially if you will be traveling alone. Consider using a satellite-based global positioning system (GPS) for accurate navigation.

### WIND

Strong, steady winds and gusty winds can affect your path. The force of a side wind can cause you to move within your lane or even out of your lane. Gusty winds often occur in open areas or mountains. As needed, adjust your path by pressing on the appropriate handgrip.

Also be prepared for air turbulence or vacuum effects around large vehicles. This can affect you when you pass or are being passed. Be prepared for the effects of large oncoming vehicles in opposing traffic, especially if the wind direction is left-to-right.

### ANIMALS

Dogs like to chase cars and motorcycles. A good response is to slow, downshift, then accelerate past the dog. Do not kick at the dog as that may upset your balance.

Larger animals such as deer and elk can be a problem. These animals tend to wander about, and hitting one can be as harmful as crashing into another vehicle. If a large animal is on or near the roadway, stop before reaching it, and wait until it leaves. Keep searching because more than one may be present.

### MAINTENANCE AND EMERGENCY ISSUES

#### Tire Failure

With modern tubeless tires, a blowout is rare. Riding with tire pressure that is too low can cause a tire to overheat and fail. It also increases tire wear and decreases fuel economy, costing you money. Check your tires frequently, and keep them properly inflated. Check the pressure when the tires are cool, before the ride. Be sure the tire tread is adequate by checking for the wear bars molded into the tires. Buy the right tires for your motorcycle and have them professionally installed.

If a tire fails, hold the handgrips firmly without fighting the steering. Avoid shifting and braking until speed is under control. If traffic permits, slow gradually and move off the roadway. If braking is necessary, use the brake on the wheel with the good tire. Using the brake on the wheel with the bad tire can cause the tire to separate from the rim. If your bike has a combined braking system, keep your brake pressure as gentle as possible.

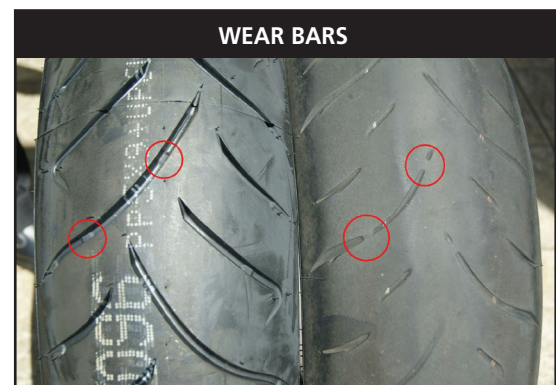

### Stuck Throttle

Although rare, a throttle may stick. If this happens, twist the throttle back and forth several times. If the throttle cable is stuck, this may free it. If the throttle stays stuck, immediately squeeze in the clutch lever and operate the engine cut-off switch. This will remove power from the rear wheel, though the engine sound may not immediately decline. Once the motorcycle is under control, stop in a safe place. After you have stopped, check the throttle cable. Make certain the throttle works freely and snaps back before you ride again.

### Clutch Cable Failure

Many motorcycles use a cable to operate the clutch. If the cable breaks, the clutch remains fully engaged. This is not a cause for panic. If it breaks while stopped, use the engine cut-off switch or brake firmly to stall the engine. If it happens while riding, the motorcycle can still be ridden, but it will be more difficult to change gears. When you need to stop, slow down gradually and downshift when speed permits. Shift to neutral before stopping to avoid a jerky stop or stalling the engine. Get the cable replaced right away.

### Weave or Wobble

A weave is a relatively slow swaying of the rear of the motorcycle. A wobble is a rapid, strong shaking of the handlebars. These are problems usually caused by excessive weight in the wrong place, by a mechanical problem, or by improper tire pressure.

For either problem, your response is the same. Keep a firm hold on the handgrips without locking your arms or fighting the steering. Ease off the throttle. Do not apply the brakes, and do not accelerate. In some cases, it helps to shift your weight forward by leaning over the tank. Be sure to get the cause of the problem corrected.

### Drivetrain Problems

The drivetrain for a motorcycle uses a chain, belt, or drive shaft to transfer power from the engine to the rear wheel. Routine inspection, adjustment, and maintenance make failure a rare occurrence. A chain or belt that slips or breaks while you are riding could lock the rear wheel and cause the motorcycle to skid. If a chain or belt breaks, you will notice an instant loss of power; close the throttle and brake to stop in a safe area. On a motorcycle with a drive shaft, loss of oil in the rear differential can cause the rear wheel to lock, and you may not be able to prevent a skid.



### Engine Seizure

If an engine locks or freezes, it is usually low on oil. The engine's moving parts cannot move smoothly against each other, and the engine overheats. The first sign may be a loss of engine power or a change in the engine's sound. Squeeze the clutch lever to disengage the engine from the rear wheel. Move off the road and stop. Check the oil. If needed, oil should be added as soon as possible or the engine will seize. When this happens, the effect is the same as a locked rear wheel. Let the engine cool before restarting.

## SECTION 11. RIDER IMPAIRMENTS

**Introduction:** There is increased crash risk associated with riding under the influence of alcohol or drugs. A rider cannot effectively manage risks if impaired, which can be a loss of physical or mental abilities. It is important to recognize when something affects your ability to ride safely.

### ALCOHOL

Alcohol is a drug and a major contributor to crashes. It reduces the ability to search for hazards (perception), evaluate factors (thinking), and execute physical actions (coordination and reaction time). Research shows that around 30 percent of fatally injured riders had a blood alcohol concentration at or above the legal limit of .08 percent.

Depressant drugs, such as alcohol, slow down the body's functions. Alcohol enters the blood quickly and reaches the brain. The effects begin after the first drink and worsen as the drug builds up in the bloodstream. Judgment and vision are usually the first abilities to suffer and fade when drinking alcohol. Most people are affected with only one drink in their system.

A standard drink contains one-half ounce of pure ethyl alcohol:

1. A 12-ounce beer.
2. A mixed drink with 1.5 ounces of distilled (hard) liquor.
3. A 5-ounce glass of wine.

Each contains about the same amount of pure alcohol. Some mixed drinks may contain more than one and one-half ounces of hard liquor.

Drinking faster than the body can eliminate the alcohol causes it to accumulate in the blood. The adult male body is able to get rid of alcohol at the rate of almost one drink per hour. If a male consumed two drinks in an hour, at the end of that hour, the alcohol from one drink is eliminated, and the alcohol from one drink remains in the blood. If four drinks are consumed in an hour, at the end of that hour, the alcohol from three drinks will remain in the blood. Women process alcohol more slowly, at about three-fourths of that rate.

Blood alcohol content (BAC) is primarily determined by three factors:

1. The amount of alcohol consumed.
2. How fast it is consumed.
3. Body weight.

A higher BAC means greater impairment. People who try to manage their BAC usually do not have much success because their judgment is impaired. A person is impaired before reaching the legal limit.

It is vital to separate drinking from riding. It is also important to avoid riding with impaired riders or carrying passengers who are impaired, as they can cause a crash.

### DRUGS

Drugs can affect the ability to ride safely, and it is difficult to know when the effects are gone. Drugs like many over-the-counter and prescription drugs, as well as illegal drugs, have effects that increase risk. They can have depressing effects or stimulating effects. Depressing drugs slow down mental and physical processes. Stimulating drugs can be harmful because they can lead to aggressive riding, and the effects can wear off suddenly and result in extreme fatigue. Combining alcohol and drugs compounds the effects.

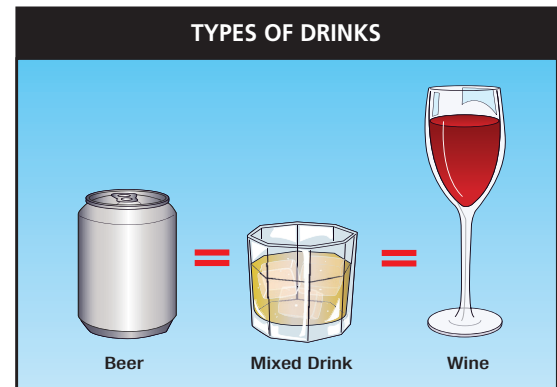

Marijuana is legal in some states for medicinal or recreational use. However, it is not legal, safe or wise to operate a motorcycle while impaired by marijuana. Its use tends to distort perception of time, space and speed. Predicting the degree and duration of impairment is difficult as potency varies. The only good choice is to separate marijuana use from riding.

### INTERVENTION

Intervention is an attempt to stop someone from doing something dangerous. A group of riders can intervene to keep an impaired rider from getting on a motorcycle. It may be difficult, but the payoff can be life-saving.

Here are some tips to help keep someone from riding after drinking:

1. Enlist others to help.
2. Call for a cab or other transportation for the impaired rider.
3. Slow the pace of drinking.
4. Delay departure.
5. Provide alcohol-free drinks and food.
6. Keep the motorcycle parked, and secure it so the rider won't worry.
7. If the rider cannot be stopped, consider hiding the keys.

### OTHER FACTORS AFFECTING SAFETY

#### Distraction

Full attention is needed to be safe on the road. Car drivers commonly use cell phones and other mobile devices. They can be eating or talking to passengers. They may be taking medication. It is up to you to be focused on your task to make up for the distracted behavior of others. Assume others are distracted or inattentive and do not see you. You can only do this by not being distracted or inattentive yourself. It is important to always be mindful of collision traps.

#### Fatigue

Fatigue as a factor in crashes has been increasing. Being fatigued or drowsy raises your risk. It may be you had a poor night's sleep or had an especially difficult day at work. When you are tired, your senses are not as sharp. You will not be as likely to see or recognize potential hazards. Your decision-making is slowed. Your physical actions are not as quick or as accurate. You will need more time and space to SEE and more-than-usual safety margins. A wise rider will stop for a rest.

#### Emotions

It is not easy to determine the effects of emotions on riding. But feeling angry, troubled, or stressed makes safe riding more difficult. Any emotion that keeps you from using a safety strategy will increase risk. Make an honest assessment of your riding priorities, and keep safety top-of-mind.

Being overconfident can lead to aggressive riding. You could put yourself in situations that require more skill than you have or more performance than your motorcycle can provide. Having too little confidence can delay decisions. It is important to have the self-awareness and foresight to confidently make decisions that reduce risk so you can take charge of your own safety. You want to be realistic about your capabilities and limitations as well as what your motorcycle can and cannot do. This way, you can make better, safer decisions in the moments of choice.

#### Aging

You want to enjoy motorcycling to the fullest for many years. Know how aging affects you so you can correct or compensate as needed.

While getting older usually brings wisdom and better judgment, aging affects health as well as many of the important physical tasks for safe riding. For example, night vision is poorer, overall strength decreases, and reaction time increases.

## SECTION 11. RIDER IMPAIRMENTS

It is important to stay fit and healthy to enjoy all aspects of life, but because motorcycling is demanding, you should take special steps. Keep up with eye and physical exams. Know if medications affect your skill and perception. Take note when others comment on changes in your riding ability.

You can help yourself by increasing your safety margins, using a greater following distance, and avoiding riding at night. Practice your riding skills often so your actions are precise, especially for emergency maneuvers such as hard braking and quick swerving. Consider the value of additional formal training.

If you find yourself having difficulty riding the way you used to, consider getting a smaller motorcycle, or even a scooter or three-wheel motorcycle.

### Riding at the Limit

Motorcycling is a great way to travel. The feeling of freedom and exhilaration are part of nearly every ride. But using poor judgment can lead to high-risk riding. Some riders choose to stay near the very limits of crashing. Aggressive riding such as challenging the road (e.g., testing how fast a corner can be ridden or competing with other riders) should be taken to a racetrack. Many track days and track schools are available around the country. Also, stunting has no place on public roads.

#### Check the space as appropriate:

- I commit to avoid riding with others who are impaired.
- I commit to minimize factors that adversely affect rider performance.
- I commit to separating the use of alcohol and other drugs from operating a motorcycle.

Below are potential topics your RiderCoach may guide you through. There are many references, including several available on the Motorcycle Safety Foundation website. Here is a link to the MSF home page: <https://msf-usa.org/>, where you can find several additional resources in the Library section such as Quick Tips booklets, riding tips and other materials to help you become the best rider possible.

### STATE LICENSING REQUIREMENTS

For details about state's laws, rules and regulations regarding operation of a motorcycle, refer to the motorcycle operator's manual available from your state, which maybe online. Also, you can check out state-specific requirements by reviewing the MSF Cycle Safety Information sheets from the MSF website.

For a general motorcycle operator's manual: [https://msf-usa.org/downloads/mom\\_v16\\_color\\_hi\\_res.pdf](https://msf-usa.org/downloads/mom_v16_color_hi_res.pdf)

For motorcycle licensing requirements: <https://msf-usa.org/downloads/State-Motorcycle-Operator-Licensing-CSI-2018.pdf>

For motorcycle equipment requirements, including personal protective gear: [https://msf-usa.org/downloads/Equipment\\_Chart\\_2019-MSFlogo.pdf](https://msf-usa.org/downloads/Equipment_Chart_2019-MSFlogo.pdf)

### CONSEQUENCES FOR IMPAIRED RIDING

#### General

Riding impaired can result in incidents that produce inconvenience, painful or disabling injuries, and even death. Additionally, there are legal, social, personal and economic consequences.

#### Impaired Riding Arrest

The most frequent cause of an impaired riding arrest is riding under the influence or riding while intoxicated caused by alcohol or other drug use or abuse. Legal consequences include fines, court appearances, jail time and even loss of license. Social consequences include personal and/or family embarrassment and lost work time. Personal consequences include financial loss, riding restrictions, and perhaps loss of the riding privilege and motorcycle impoundment. Economic consequences include fines and legal representation, increased insurance costs, and possible transportation costs.

### SUMMARY

Safety requires riders and drivers to be unimpaired, predictable, courteous and cooperative. Remember to maintain good risk offset. The riding skill you possess must exceed the risk you take. What is needed can be referred to as rider character, which means to choose safe and responsible riding practices. This can result if a lifetime of great riding and memorable experiences.

#### Check the space as appropriate:

\_\_\_\_\_ I have reviewed or will review the State laws, rules and regulations for the operation of a motorcycle and equipment requirements, and I commit to comply with them.

## SECTION 13. KEY SAFETY CONCEPTS

### SELF-ASSESSMENT

Judgment includes having an informed opinion based on past experience. The result of using good judgment is a safe ride. Having safety as a core value and keeping it top-of-mind takes commitment and forms the basis for making good choices.

It is a wise rider who keeps their skills at a much higher level than the risks they take. A good rider has excellent skills and chooses to behave safely. Continuous self-assessment within a good value system builds rider character. The more you make good choices, the better riding gets.

### TERMS AND CONCEPTS FROM THE COURSE

Now that you have a good start in motorcycling, it is important to put into practice the skills and strategies you have learned. Here are some reminders.

**360° Awareness:** To perceive factors in front, back, left, and right.

**ATGATT:** To use All The Gear, All The Time.

**Entry Speed:** The speed at the beginning of the turn or curve that allows you to maintain or increase speed while in the turn or curve.

**Escape Path:** An open area in front, to the right, or to the left. An open area behind is good, too, so there is room to slow.

**Open Up the View:** To be in a position when stopped at an intersection to see and be seen.

**Presentation:** To use a lane position to be seen by opposing traffic.

**Respond vs. React:** To take action ahead of time (respond) instead of having to instantly react to an emergency.

**Ride Your Own Ride:** To honestly self-assess and ride within personal, motorcycle, situational, and legal limits, unaffected by what others may think.

**Rider Character:** To choose to do the right (safe, responsible) thing.

**RiderRadar:** To keep the eyes moving (scan) and mind thinking about interacting factors and hazards.

**Risk Offset:** The difference between a rider's skill and the risks taken; good risk offset is when skill exceeds risk.

**SEE:** Refers to Search-Evaluate-Execute, a riding strategy.

**Separate:** To adjust speed and/or lane position to meet potential hazards at different points in time.

**Space Cushion:** To keep space around you open.

**Trap:** To not have a space cushion or escape path.

In learning to ride a motorcycle, perhaps you also became aware of how you process information or make decisions. It is important to keep safety as a top-of-mind value every time you ride (or drive). A good rider constantly regulates personal behavior to achieve a worthy goal: being a responsible and crash-free rider.

The end-of-course knowledge test consists of 25 questions. You must score at least 80 percent correct in order to successfully complete the Basic *RiderCourse*. Follow RiderCoach instructions to complete the test.

### OPTIONAL MSF LEARNING ACTIVITY

## MOTORCYCLE CRASH SCENARIOS

Here are four motorcycle crash scenarios. Read each one and determine what you think the cause of the crash might be.

### Scenario #1

A rider was travelling east on a 2-lane country road as the sun was setting. It was Saturday, and the rider had just left a small get-together, where a few drinks were consumed. The rider's BAC was .06 percent. The rider approached an intersection (where cross traffic had stop signs) at 45 mph (the speed limit was 35 mph). An automobile pulled across the road, blocking the lane. The rider braked hard, the motorcycle skidded and glanced off the rear bumper of the car, and the rider was thrown clear, sliding 30 feet to the curb. The rider wasn't wearing a helmet. What was the cause of this crash?

### Scenario #2

The rider was travelling in the country over hilly terrain that included some sharp curves. Traveling in a leisurely fashion, the rider was enjoying the beautiful scenery while passing the overlooks along the highway. A camper ahead slowed to turn into a parking area, but the rider saw it too late. Using no front brake, the rider over-braked the rear wheel causing a skid, and slammed into the rear of the camper. Investigation revealed that the camper's brake lights were not functioning, and that no turn signal was used. What was the cause of this crash?

### Scenario #3

A group of four riders was traveling on a two-lane country road. They were riding within the speed limit. They chose a staggered formation, but they were bunched up too close together. As they were in the middle of a rather sharp curve to the left, the first rider slid on some loose gravel that had fallen from a maintenance truck. The rider went down, and the second rider in the group had to go off into a ditch on the right side to avoid hitting the first rider. Neither rider was hurt badly, but the clutch levers of both bikes were broken. What was the cause of this crash?

### Scenario #4

A rider was heading toward the local motorcycle shop to get a part for the motorcycle. The shop was in the middle of town. The Saturday morning traffic was light. As the rider approached the dealership, which was just past an intersection on the left, the rider scanned for a parking place near the front door. A motorist on the intersecting road, having already stopped at a stop sign at the intersection, pulled out and hit the rider. The crash resulted in a broken leg for the rider. What was the cause of this crash?



## SECTION 15. NEXT STEPS

You have learned a lot of material in this course. You now have the very basic skills and can determine if you are ready for the street. Be sure to keep your first several rides simple, such as side streets and lightly-traveled roads.

The controls on your own motorcycle will generally operate the same as those on the motorcycle you used in this course, but they may take getting used to. The same is true for a heavier motorcycle or one with a higher seat. You will want to control your motorcycle well so you can devote attention to circumstances in traffic. With success and experience, you will get better at using *SEE* and can try more demanding riding situations.

Consider taking the classroom-based Street Smart – *Rider Perception* program which, as the name suggests, helps you to improve your perception. This highly interactive program will engage you in analyzing common situations that get riders in trouble. If you are comfortable making presentations, lead a Street Smart – *Rider Perception* program for others. The cost of the kit is minimal.

The MSF provides additional training opportunities as part of its Rider Education and Training System (RETS), which is designed to provide you with lifelong learning opportunities. We hope you take advantage of these courses.

Choose a *RiderCourse* that best meets your needs. RiderCoaches are eager to help you. Here are a few key points about some of these MSF courses:

**Basic Bike Bonding *RiderCourse*:** This 4-5 hour course is all riding and helps you handle a motorcycle better. It improves basic maneuvering skills and helps you understand more about how a motorcycle handles. You may use a training motorcycle or your own motorcycle.

**Basic *RiderCourse 2*:** Uses many of the same exercises you experienced in this course, but on your own motorcycle. This 4-5 hour course has no formal classroom time. Discussions are held between riding exercises. Exercise speeds are a bit higher. There is more braking and cornering practice. The course helps you handle your motorcycle better, which means you improve steering and braking so your responses become more automatic.

**Street *RiderCourse*:** In the SRC, you ride your motorcycle on the street under the supervision of a RiderCoach. There is an SRC 1 and an SRC 2. SRC 1 is for newly licensed riders who would like their first venture out onto the street to have supervision. SRC 2 is for riders with extensive experience who wish to add finesse to their riding strategies. After brushing up on the fundamentals with some range exercises, you move to the street with a few other riders. Several routes are used, starting with a simple residential area and progressing to more complex situations. Stops are made along each route to discuss experiences and improve strategies.

**Advanced *RiderCourse*:** This one-day course includes techniques used by riders who have a lot of experience. It is not about riding fast, but about riding better. Having more refined skills can help you improve your basic riding techniques and can also help you in an emergency. There is an interactive classroom segment that adds to the basics. There is more information about braking, cornering, and emergency maneuvers. Riding exercises include quick stops, special cornering drills, and decreasing-radius curves. You should be comfortable with the basics of riding at highway speeds before enrolling in this course.

**Ultimate Bike Bonding *RiderCourse*:** This 4-5 hour course is patterned after police motorcycle training courses and will help you handle your motorcycle. The UBBRC does not have a formal classroom component. You use your own motorcycle in this course.

**MSF Circuit *RiderCourse*:** The MSF CRC takes place on a closed, paved area much larger than the Basic *RiderCourse*. It emphasizes visual awareness and handling your motorcycle at higher speeds, especially when braking and riding in curves. The course was developed in cooperation with champion racers Kevin Schwantz and Nick Ienatsch, who operate advanced riding schools conducted on racetracks around the world.

See the back of this handbook for classroom-only programs and additional lifelong learning resources. Check out the library section on the MSF website. Also, the concepts discussed in this course are presented in greater detail in a variety of MSF publications, including the book, *The Motorcycle Safety Foundation's Guide to Motorcycling Excellence*, 2nd edition, available through [msf-usa.org](http://msf-usa.org). Check the MSF website often for updated safety information.

If you completed the MSF Basic *eCourse* as part of this BRC, remember it is accessible to you at any time with no additional cost. If you have not completed it, consider enrolling in it to reinforce the content in the BRC.

The MSF hopes this course has been, for you, a valuable introduction to the world of motorcycling. We wish you a long and enjoyable life of riding.

# SECTION 16. RANGE PREPARATION

## RANGE SAFETY RULES

These are the range safety rules. They help keep learning positive. You must follow these rules:

1. Do not practice without RiderCoach permission.
2. Always wear all your protective gear when seated on the motorcycle, even when the engine is off.\*
3. Know the location of the engine cut-off switch and how to use it.
4. Keep the clutch lever covered during early skill development (especially the first few exercises). This is because a quick squeeze of the lever will remove engine power from the rear wheel. Always be prepared to reach and squeeze it.
5. If you start to accelerate out of control, squeeze in the clutch lever and apply the brakes.
6. Be ready to roll off the throttle to use the front brake lever. Keep your fingers around the throttle with your wrist *flat* to help with handlebar and throttle control.
7. Keep a time-and-space safety margin; check front, sides, and rear before moving out.
8. Yield to other riders as necessary.
9. Use courtesy and cooperation when sharing the range.
10. Do not pass other riders unless directed to do so.
11. If you have a problem, move out of the path of travel if you can, and stop. A RiderCoach will assist you.
12. Stop smoothly in position if you see or hear a group stop signal.
13. If you get behind in an exercise, do not hurry your actions to catch up. Take your time.
14. If you have a tip-over, do not pick up the motorcycle. Be sure the engine is off. A RiderCoach will help.
15. If you do not understand an exercise or become too uncomfortable to ride it safely, let a RiderCoach know.

\* Proper protective riding gear for the range includes a helmet designed to meet DOT standards, eye protection, long sleeves, full-fingered gloves, long pants, and sturdy boots or shoes that cover the ankles.

## RIDERCOACH SIGNALS

RiderCoaches use hand signals during the riding exercises. Common signals include *engine start*, *engine stop*, *ready to start out*, *speed up*, *slow down*, *stop*, and *increase space*. These and other signals will be demonstrated.

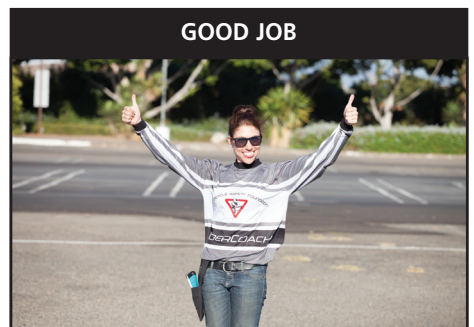

### HOW THE RANGE EXERCISES WORK

There are 14 riding exercises before the skill test. The exercises give you a step-by-step, building block process for learning to ride. You are allowed to ask questions at any time. Here is what happens in each exercise:

1. Your RiderCoach tells you the name of the exercise and the objective. Listen closely to the objective because it helps you focus your learning.
2. The general range setup will be described so you know what parts of the range are used.
3. You will be given specific instructions and a demonstration of where to go and what to do.
4. A RiderCoach will provide timely tips to help you with the proper path of travel as well as with riding procedures and techniques.
5. Many exercises include practice on the motorcycle with the engine off before actually riding. These simulated practices have you think about what you will do on the range.

Upon exercise completion, you may be asked questions like: What went well and why? What do you need to improve upon? These questions help you understand the value of the skill and develop the habit of thinking and reflecting about your riding. Future success requires self-assessment, which is taking a look at yourself and how you are doing.

## GLOSSARY

**2-second following distance** – refers to minimum distance needed when following another vehicle

**4-second urgent distance** – refers to the distance needed to react to immediate hazards ahead

**12-second anticipation distance** – refers to the time and distance needed to prepare for and respond to factors ahead

**360° Awareness** – perceive factors front, back, left, and right

**ATGATT** – All The Gear, All The Time

**Alcohol** – specifically ethyl alcohol, a depressant drug consumed as a beverage

**Anti-lock braking system (ABS)** – type of braking system that automatically releases braking pressure to prevent skidding

**Apex** – the middle or sharpest point in your path around a curve

**BAC** – blood alcohol concentration: percentage, by volume, of ethyl alcohol in the blood

**Blind spot** – area behind or to the side not seen in the mirrors, or area blocked from view by an object

**Braking distance** – space traveled between brake application and completed stop

**Contact patch** – portion of a tire that touches the road surface

**Convex mirrors** – mirrors designed with an outwardly curved surface; shows more area but objects are closer than they appear in the mirror

**Countersteer** – a momentary steering deflection away from the intended direction of travel caused by pressing on the handgrip in the direction of the turn; used to produce a lean and turn in the desired direction; press right handgrip, lean right, go right; press left handgrip, lean left, go left

**Counterweight** – used primarily in slow, tight turns; rider shifts weight opposite to the lean of the motorcycle

**Crowned road** – road surface that is higher in the middle for rain runoff

**Decreasing radius** – refers to a turn or curve that becomes progressively tighter

**DOT** – stands for U.S. Department of Transportation; an official DOT label on a helmet indicates a helmet has been manufactured to meet DOT performance standards as required by federal law

**Engine braking** – slowing by shifting down and easing out the clutch lever to use the engine as a braking force

**Entry speed** – the speed at the point where the steering input occurs to lean into a turn. The maximum desired entry speed is one that allows for some throttle roll-on to maintain speed, smoothness, and stability

**Escape path** – a path of travel that is open and allows you to avoid a collision

**Factors** – refers to elements that affect your speed, lane position, or path of travel

**FINE-C** – acronym for the engine pre-start checklist: Fuel valve, Ignition switch, Neutral, Engine cut-off switch, Clutch/Choke

**Friction zone** – small area of clutch lever movement where power begins to be transmitted to the rear wheel; used to get under way from a stop, to control speed when riding slowly, and to ensure smooth downshifts when engine braking

**Gauntlets** – refers to the protective part of gloves that extend past the wrist

**Heat exhaustion** – body weakness caused by heat

**High-side fall** – fall in which the rider loses control and is thrown to ground in front of the motorcycle's path.

**Hydroplaning** – water buildup under the tires resulting in loss of traction

**Hypothermia** – subnormal body temperature due to the cooling effects of air on exposed skin

**Integrated brakes** – braking system where use of the rear brake applies partial front brake pressure

- Lane position** – a lane can be divided into three general positions: the left third of a lane (LP1), the middle third of a lane (LP2), and the right third of a lane (LP3)
- Legal limit** – the BAC level a state uses for intoxication. Currently, 0.08% for adults nationwide and 0 to 0.02% for minors, depending on the state
- Linked brakes** – system that applies brake pressure to both brakes when either brake control is applied
- Lugging** – rough or jerking operation due to using a gear that is too high for current speed
- No-Zone** – the area around a truck or other vehicle that is a blind spot
- Open Up the View** – to be in a position to see and be seen at an intersection stop; may require more than one stop
- Override the headlight** – riding at a speed at night where total stopping distance exceeds the sight distance of headlight illumination
- Perception distance** – distance traveled from when a hazard is present to when it is first noticed
- Peripheral vision** – area to the sides that can be seen while looking straight ahead
- Presentation** – use a lane position to be seen by opposing traffic
- Reaction distance** – space traveled between perceiving a hazard and taking action
- Red line** – the line on a tachometer that indicates maximum safe engine speed
- Reflective or retro-reflective** – ability of a surface to reflect light
- Rev** – causing the engine rpm to increase by applying throttle
- Ride Your Own Ride** – assess your own capabilities and limitations and take action within those limits. Avoid peer pressure to ride beyond current skill level or state of mind
- Rider character** – choosing to do the right (safe, responsible) thing
- RiderRadar** – refers to searching far and near and from side-to-side. The three lead-times of RiderRadar are: a 2-second following distance, a 4-second urgent distance, and a 12-second anticipation distance
- Risk offset** – refers to differences between skill level and risk level. Good risk offset is when skill exceeds risk; bad risk offset is when risk exceeds skill; responsible riders make sure they have plenty of good risk offset
- SEE** – an acronym for a riding strategy: Search-Evaluate-Execute
- Separate** – make speed and/or position changes to meet potential hazards at different points in time
- Space cushion** – distance between you and hazards
- Square the handlebars** – refers to centering the steering with the motorcycle upright and pointing in a straight line
- T-CLOCS** – an acronym for the motorcycle pre-ride inspection checklist (Tires and wheels; Controls; Lights and mirrors; Oil and other fluids; Chassis; Stands)
- Tailgating** – following at a distance of less than two seconds
- Target fixation** – to focus on something too long; to look at an object you are trying to avoid, which may result in failing to avoid the object
- Threshold braking** – using the brakes fully without producing a skid
- Total stopping distance** – refers to the combined distances of perception distance, reaction distance, and braking distance
- Traffic-actuated** – signal lights at intersections where sensors recognize the presence of a vehicle to trigger the light to change
- Tread** – the pattern molded into the face of a tire to help displace water

## GLOSSARY

**Visibility** – ability to see; also used to refer to the characteristic of being seen (conspicuity)

**Visual lead times** – part of a strategy in using the eyes and mind to reduce and manage risk: 2-second following distance; 4-second urgent distance; 12-second anticipated distance

**Wear bar** – a tread indication molded into the tire to show when a tire is worn out

**Weave** – a relatively slow oscillation of the rear of the motorcycle

**Wobble** – a rapid oscillation of the front wheel and steering components usually due to a mechanical problem

Name \_\_\_\_\_ Date \_\_\_\_\_

## Welcome and Section 1. Course Introduction

1. Why is motorcycling considered serious fun?
2. Learning to ride and ride well requires what physical traits?
3. What do RiderCoaches do?
4. What are the four requirements for successful course completion?
5. When does a RiderCoach not permit further riding in the course?

## Section 2. Motorcycle Types

6. What are the three basic motorcycle types?
7. Pick the motorcycle type you will likely ride and explain why.

## Section 3. Controls, Indicators and Equipment

8. List the six primary controls.
9. How do you operate the motorcycle's throttle?
10. What does the clutch lever do?
11. How is the gearshift lever operated?
12. What is a shift pattern?
13. How are the two brake controls operated?
14. What are possible positions on the fuel valve?
15. What are possible positions on the ignition switch?
16. What is the choke control used for?
17. Why does a motorcycle have an engine cut-off switch?
18. What are some common indicators that display information?
19. What is important to know about a convex mirror?
20. What is the difference between a side stand and center stand?
21. Complete the Controls Quiz on page 7 and check your answers.

## Section 4. About Basic Operation

22. List the five steps of the engine pre-start routine.
23. What are the three steps to follow when shutting off the engine?
24. What is the friction zone?
25. What does squeezing the clutch lever do?
26. What must you do if you start to lose control of the motorcycle?
27. What is the position of the right wrist for good riding posture?
28. What are the other elements of proper riding posture?
29. How do you initiate motorcycle lean at speeds higher than walking speed?

## STUDY QUESTIONS

30. What are the four action steps for making a basic turn?
31. What is the three-step strategy for curves and what does each step mean?
32. In what type of turn does counterweighting help?
33. What gear should you be in when coming to a stop and why?
34. What is the benefit of squaring the handlebars when coming to a stop?
35. Why does the front brake have more stopping power than the rear brake?
36. How does the motorcycle's weight shift during braking?
37. How do you stop in a curve?
38. Why do you change gears?
39. List the three-step process to shift to a higher gear.
40. List the three-step process to shift to a lower gear.
41. What is engine braking?
42. What is the position of the clutch lever when making a stop?

### Section 5. Preparing to Ride – the Four Preps

43. List the four preparations.
44. How should your motorcycle fit you?
45. What is T-CLOCS and what does each letter stand for?
46. List the three primary purposes of riding gear.
47. What does ATGATT mean?
48. What type of injury accounts for the majority of motorcycle-related deaths?
49. What are the four basic parts of a helmet?
50. What is the difference between a full-face-coverage helmet and three-quarter-coverage helmet?
51. What stickers are likely to indicate a well-made helmet?
52. How should a helmet fit?
53. What are some tips to care for a helmet?
54. Are ordinary glasses or sunglasses alone sufficient eye protection?
55. What types of eye and/or face protection can a rider choose?
56. Name four considerations about eye and face protection.
57. What is the value of appropriate footwear?
58. What features of a full-fingered glove help a rider?
59. What is the value of motorcycle-specific clothing?
60. How can motorcycle riding gear make you more visible?
61. What are some features your gear should have if you are riding in rain or cold weather?
62. Define hypothermia.
63. What is wind chill?
64. What is the value of dressing in layers?
65. What should you be cautious of in hot weather?

66. In what way can riding a motorcycle affect hearing and what can be done?
67. What does it mean to have a good mental attitude?

## Section 6. Risk & Riding

68. Where do most crashes occur?
69. Name three reasons why riding a motorcycle involves more risk than driving a car or truck.
70. What is the primary cause of motorcycle-related crashes?
71. What questions help you think about the risks of riding?
72. After learning to ride, why is safety more about mental skills than physical skills?
73. List the three key safety margins.
74. What are five characteristics of a rider who manages risk properly?
75. What does it mean to have good risk offset?

## Section 7. Basic Street Strategies

76. What does it mean to have a good lane choice?
77. What is the purpose of using three different positions within a lane?
78. What is the start position?
79. Name three smart ways to be more visible (conspicuous) to others in traffic.
80. What are the 3 visual lead times of RiderRadar?
81. Why is the 2-second following distance considered minimum?
82. How are the 4-second urgent time/distance and total stopping distance related?
83. Name the 3 parts of total stopping distance.
84. How can you reduce total stopping distance (TSD)?
85. What does it mean to Search?
86. What are the four search categories?
87. What does it mean to Evaluate?
88. What are the three action steps of Execute?
89. What are some environmental conditions that may be hazardous and what can you do?
90. What is an escape path?
91. What is the danger with target fixation?

## Section 8. Strategies for Common Riding Situations

92. Where is the greatest potential for conflict between a rider and other traffic?
93. What is 360° awareness?
94. What is Presentation?
95. What does it mean to Open Up the View?
96. Why is turning from a stop an important skill?
97. What are some tips for turning from a stop?

## STUDY QUESTIONS

98. What are some hazards between intersections?
99. In what ways do cars and motorcycles have blind spots?
100. What is the No-Zone?
101. What is the proper technique for lane changes?
102. What are some things to be aware of when merging?
103. When merging onto a freeway, why match speed to traffic flow?
104. What are the three curve types?
105. What are the three curve parts?
106. What are the three lane positions used for curves?
107. What are some factors to search for when approaching a curve?
108. What should be assumed about a curve if you cannot see to its end?
109. What is the advantage of using a delayed apex in a curve?
110. What are some tips for making a low-speed U-turn?
111. What makes starting out on a hill (upgrade) more difficult?
112. Why rise off the seat when crossing an obstacle?
113. How is the throttle used when crossing an obstacle?
114. Why park with the front wheel facing out of a parking space?
115. What are some tips for keeping your motorcycle secure while it is parked?
116. What is a proper technique for passing and how are lane positions used?
117. What is a good way to respond to a tailgating driver?
118. List a few tips for riding at night or in limited visibility conditions.
119. What does it mean to override the headlight?
120. Why should you have good basic skills before riding in a group?
121. What is the benefit of knowing group riding signals?
122. When would you use staggered, side-by-side, or single-file riding formations?
123. What are some things to avoid when riding with others?
124. What are some personal considerations when riding in a group?

### Section 9. Basics for Emergencies

125. How will you find out your motorcycle's type of braking system?
126. What is the best way to achieve the shortest braking distance in a straight line?
127. What is threshold braking?
128. What complicates an emergency stop in a curve?
129. What are two methods of braking in a curve and when might you use each?
130. What should you do if the front tire skids because of too much brake pressure?
131. What should you do if the rear tire skids because of too much brake pressure?
132. Why is it a good idea to avoid using the brakes (or rolling off the throttle) during a swerve?
133. What is your body position during a swerve?

134. How do you know whether to brake first or swerve first for an emergency?

#### Section 10. Special Riding Situations

135. Why is a surface most slippery as it begins to rain?

136. What is hydroplaning?

137. List three road-surface conditions that could affect traction.

138. How can you adjust for the effects of surface hazards and/or reduced traction?

139. How can a crowned road affect riding?

140. Why is it a good idea to gain experience before carrying a passenger or heavy cargo?

141. How does carrying a passenger or cargo affect motorcycle operation?

142. What should happen as a passenger mounts and dismounts?

143. What are some tips for your passenger while riding?

144. What can be used to fasten cargo?

145. Where can you find your motorcycle's load limit?

146. What are some tips for carrying cargo?

147. Why should new riders limit long-distance riding until they gain experience?

148. What are some special considerations for touring or riding long distances?

149. What should you carry with you while touring or riding long distances?

150. What can you do to avoid fatigue and maintain health when touring?

151. Where might you encounter wind, wind gusts, or turbulent air conditions?

152. How should you adjust for windy conditions?

153. What is a good strategy to get by a dog that might chase you?

154. What are some maintenance issues that could lead to an emergency?

#### Section 11. Rider Impairments

155. Why is there increased crash risk associated with riding under the influence of alcohol or drugs?

156. What are the first abilities affected by alcohol?

157. What other abilities are affected by alcohol and drugs?

158. How much beverage alcohol equals one drink?

159. How fast is alcohol eliminated from the bloodstream?

160. How can drinking alcohol and riding a motorcycle both be enjoyed?

161. Why should you avoid riding with passengers or others who are impaired?

162. What are some drugs that affect the ability to ride safely?

163. How long will it take for the effects of drugs to wear off?

164. What happens if alcohol and other drugs are combined?

165. What is the best way to approach intervention, and what are some other intervention methods?

166. What besides alcohol and drugs can affect riding safely?

167. What are some factors that contribute to distraction and/or inattention?

## STUDY QUESTIONS

168. What contributes to fatigue or drowsiness, and what affects does fatigue have on riding?
169. What effect can emotions have on your riding?
170. What problems may be caused by over- or under-confidence?
171. How can rider performance be affected by aging or health problems?
172. What does Riding at the Limit mean?
173. What is rider character?

Sections 12-15: No questions from these sections.

Section 16. Range Preparation

174. List the personal riding gear needed for the range.
175. What will happen at the end of each exercise and why?

There are 10 activity sheets on the following pages labeled A-1 to A-10. These are used in some Basic *RiderCourse* programs. Follow RiderCoach instructions for their use.

A PUBLIC SERVICE ANNOUNCEMENT FROM MSF

# Ten Things All Car & Truck Drivers Should Know About Motorcycles

1

Over half of all fatal motorcycle crashes involve another vehicle. Most of the time, the car or truck driver, not the motorcyclist, is at fault. There are a lot more cars and trucks than motorcycles on the road, and some drivers don't "recognize" a motorcycle – they ignore it (usually unintentionally).

2

Because of its narrow profile, a motorcycle can be easily hidden in a car's blind spots (door/roof pillars) or masked by objects or backgrounds outside a car (bushes, fences, bridges, etc). Take an extra moment to look for motorcycles, whether you're changing lanes or turning at intersections.

3

Because of its small size, a motorcycle may look farther away than it is. It may also be difficult to judge a motorcycle's speed. When checking traffic to turn at an intersection or into (or out of) a driveway, predict a motorcycle is closer than it looks.

4

Motorcyclists often slow by downshifting or merely rolling off the throttle, thus not activating the brake light. Allow more following distance, say 3 or 4 seconds. At intersections, predict a motorcyclist may slow down without visual warning.

5

Motorcyclists often adjust position within a lane to be seen more easily and to minimize the effects of road debris, passing vehicles, and wind. Understand that motorcyclists adjust lane position for a purpose, not to be reckless or show off or to allow you to share the lane with them.

6

Turn signals on a motorcycle usually are not self-canceling, thus some riders (especially beginners) sometimes forget to turn them off after a turn or lane change. Make sure a motorcycle's signal is for real.

7

Maneuverability is one of a motorcycle's better characteristics, especially at slower speeds and with good road conditions, but don't expect a motorcyclist to always be able to dodge out of the way.

8

Stopping distance for motorcycles is nearly the same as for cars, but slippery pavement makes stopping quickly difficult. Allow more following distance behind a motorcycle because you can't always stop "on a dime."

9

When a motorcycle is in motion, see more than the motorcycle – see the person under the helmet, who could be your friend, neighbor, or relative.

10

If a driver crashes into a motorcyclist, bicyclist, or pedestrian and causes serious injury, the driver would likely never forgive himself/herself.

Please Look For Motorcyclists



Name \_\_\_\_\_

Date \_\_\_\_\_

Directions: Respond to the following questions and statements.

1. I am able to ride a bicycle. Yes \_\_\_\_ No \_\_\_\_
2. T-CLOCS refers to:
  - a. A pre-ride inspection routine.
  - b. An engine pre-start routine.
  - c. Steps to mount and dismount a motorcycle.
  - d. Having 360-degrees of visual awareness. Answer \_\_\_\_
3. FINE-C refers to:
  - a. A pre-ride inspection routine.
  - b. An engine pre-start routine.
  - c. Steps to mount and dismount a motorcycle.
  - d. Performing maintenance checks before each ride. Answer \_\_\_\_
4. The benefits of proper riding gear include:
  - a. Protection, visibility, and style.
  - b. Protection, comfort, and visibility.
  - c. Fashion and protection.
  - d. Color coordinating with a motorcycle. Answer \_\_\_\_
5. Which is true about a motorcycle helmet?
  - a. There are no standards for motorcycle helmet construction.
  - b. It makes it harder to see and hear important factors in traffic.
  - c. It helps prevent injury from the number one cause of crash deaths.
  - d. A bicycle helmet is just as good. Answer \_\_\_\_
6. When you squeeze the clutch lever:
  - a. Engine power is removed from the rear wheel.
  - b. You cause the motorcycle to speed up.
  - c. You cause the motorcycle to change gears.
  - d. The engine is likely to stall. Answer \_\_\_\_
7. When stopping, squaring the bars keeps the motorcycle upright and easier to hold up. Yes \_\_\_\_ No \_\_\_\_
8. From the image below, place the number of the control in the space provided.

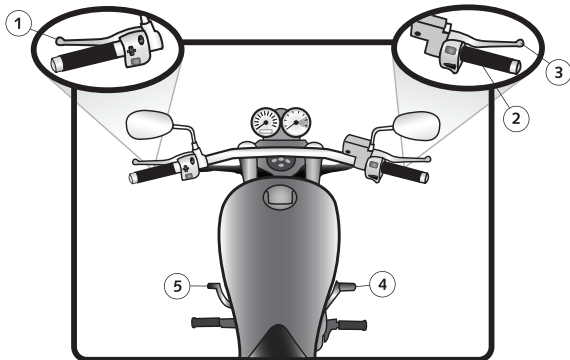

- Shift lever \_\_\_\_
- Rear brake pedal \_\_\_\_
- Throttle \_\_\_\_
- Front brake lever \_\_\_\_
- Clutch lever \_\_\_\_



## SELECT FACTORS – AT AN INTERSECTION

A-2

1 Rider	2 Motorcycle	3 Roadway/Environment
<ol style="list-style-type: none"> <li>1. Fatigue</li> <li>2. Distracted</li> <li>3. Speed too fast</li> <li>4. Inattention</li> <li>5. Poor lane positioning</li> <li>6. Too close to center line</li> <li>7. Too close to parked cars</li> <li>8. Not looking far enough ahead</li> <li>9. Target fixating</li> <li>10. No helmet</li> <li>11. High BAC</li> <li>12. Affected by medication</li> <li>13. Showing off</li> <li>14. Trying to beat a yellow light</li> <li>15. Looking at sidewalk activity</li> </ol>	<ol style="list-style-type: none"> <li>1. Bike too large for rider</li> <li>2. Bike too powerful for rider</li> <li>3. Under-inflated tires</li> <li>4. Worn tires</li> <li>5. Dry-rotted tires</li> <li>6. Sticky throttle</li> <li>7. Missing front brake lever</li> <li>8. Worn rear brakes</li> <li>9. Broken brake light</li> <li>10. Headlight out</li> <li>11. Overloaded</li> <li>12. Loose tank bag</li> <li>13. No turn signal</li> <li>14. Bent handlebars</li> <li>15. No mirrors</li> </ol>	<ol style="list-style-type: none"> <li>1. Sun glare</li> <li>2. Pedestrian crosswalks</li> <li>3. Construction</li> <li>4. Dip in road surface</li> <li>5. Oncoming driver not paying attention</li> <li>6. Driver on cell phone</li> <li>7. Debris on surface</li> <li>8. Downhill grade</li> <li>9. Malfunctioning traffic signal</li> <li>10. Parked car pulls out</li> <li>11. Night</li> <li>12. Manhole covers in path</li> <li>13. Raining</li> <li>14. Slick surface</li> <li>15. Foggy conditions</li> </ol>

Note: Crashes usually consist of an interaction of factors. Eliminating just one factor has the potential to prevent a crash. Sometimes only one factor is enough to produce a crash. There are many more than these 45 factors and potential combinations number in the thousands. A strategy to reduce risk must be ever-present.

## SELECT FACTORS – IN A CURVE

1	2	3
Rider	Motorcycle	Roadway/Environment
<ol style="list-style-type: none"> <li>1. Speed too fast</li> <li>2. Inattention</li> <li>3. Poor lane positioning</li> <li>4. Too close to center line</li> <li>5. Too close to shoulder</li> <li>6. Not looking far enough ahead</li> <li>7. Target fixating</li> <li>8. Fatigue</li> <li>9. No helmet</li> <li>10. High BAC</li> <li>11. Distracted</li> <li>12. Looking at the scenery</li> <li>13. Affected by medication</li> <li>14. Showing off</li> <li>15. Trying to keep up with others</li> </ol>	<ol style="list-style-type: none"> <li>1. Bike too large for rider</li> <li>2. Bike too powerful for rider</li> <li>3. Dry rotted tires</li> <li>4. Worn tires</li> <li>5. Under-inflated tires</li> <li>6. Sticky throttle</li> <li>7. Tire blowout</li> <li>8. Engine out of tune</li> <li>9. Bent frame</li> <li>10. Too much play in swing arm</li> <li>11. No mirrors</li> <li>12. Bent handlebars</li> <li>13. Overloaded</li> <li>14. Worn rear brakes</li> <li>15. Brake fade on downhill grade</li> </ol>	<ol style="list-style-type: none"> <li>1. Sun glare</li> <li>2. Dip in road surface</li> <li>3. Construction in area</li> <li>4. Bump in road surface</li> <li>5. Vehicle pulls out from shoulder</li> <li>6. Other driver on cell phone</li> <li>7. Oncoming driver not paying attention</li> <li>8. Debris on surface</li> <li>9. Downhill grade</li> <li>10. Off-camber surface</li> <li>11. Night</li> <li>12. No painted lines</li> <li>13. Raining</li> <li>14. Unmarked decreasing-radius curve</li> <li>15. Foggy conditions</li> </ol>

Note: Crashes usually consist of an interaction of factors. Eliminating just one factor has the potential to prevent a crash. Sometimes only one factor is enough to produce a crash. There are many more than these 45 factors and potential combinations number in the thousands. A strategy to reduce risk must be ever-present.

Directions: Place an X along the line in a position that best describes your regular car driving tendencies.  
Imagine how someone who knows you well might score you.

Hurried	← ----- →	Relaxed
Impulsive	← ----- →	Steady
Overconfident	← ----- →	Confident
Easily Distracted	← ----- →	Focused
Rebellious	← ----- →	Compliant
Non-conformist	← ----- →	Cooperative
Disrespectful	← ----- →	Respectful
Reckless	← ----- →	Forethought
Arrogant	← ----- →	Humble
Risky Thrill Seeker	← ----- →	Safe Thrill Seeker
Irresponsible	← ----- →	Responsible
Stressed	← ----- →	Calm

People tend to drive as they live, and most drivers rate themselves as above average.  
Drivers who are generally safety-minded when driving will likely be safety-minded when riding.

Warning: A temporary or momentary lapse to the left side can have negative results.

A 24 KK 3 DD B  
M I 19 HH  
4 E OO SS 23 7 R  
20 J LL  
16 GG U WW PP 15 XX Z TT  
Q CC 12 Y 8 F V 11 N  
S 26 18 L ZZ H 9  
II K UU 5 17  
C 2 AA 6 FF VV D  
10 YY G 21 T NN  
EE O MM RR 1 X JJ BB  
14 W QQ P 25 13  
22



# VISION AND REACTION TIME SCORE SHEET (NON-MEDICAL LEARNING ACTIVITY)

A-6

Date & Initials \_\_\_\_\_

### Visual Acuity

Visual acuity refers to clearness of vision. Normal visual acuity is commonly referred to as 20/20, meaning you see at 20 feet what a person with normal vision sees at 20 feet. This number is used for both eyes or for each eye individually. If the second number is higher, like 20/40, this indicates weaker visual acuity (you see at 20 feet what a person with 20/20 visual acuity can see at 40 feet). If the second number is lower, like 20/15, this indicates better-than-average visual acuity (you see at 20 feet what a person with 20/20 visual acuity sees at 15 feet).

**Visual acuity:** Both eyes: \_\_\_\_\_ Left eye: \_\_\_\_\_ Right eye: \_\_\_\_\_

### Peripheral Vision

Peripheral vision refers to how well you see to the sides while looking straight ahead. While central, clear vision is a three-degree cone (and our eyes move so quickly our surroundings mostly look in focus), peripheral vision can exceed 90 degrees per side.

<b>Peripheral vision</b> (first see the card):	<b>Either side</b> _____
<b>Useful field of view</b> (see color of card):	<b>Either side</b> _____
<b>Central vision</b> (see actual card):	<b>Either side</b> _____

(Less than 140 degrees of total peripheral vision is considered tunnel vision.)

### Reaction Time

Simple reaction time refers to how quickly a person responds to a stimulus that is anticipated. Reaction time varies among individuals and is affected by perception time. One way to check a person's general reaction time is to catch a ruler dropped between two fingers. Where the ruler is caught indicates reaction time. Try 10 times to get 10 scores. The average catch is between the 5- and 7-inch marks.

Score for each catch: \_\_\_\_\_  
\_\_\_\_\_

**My average:** \_\_\_\_\_ (Factors: age, fatigue, priority, and distraction)

**As a car or truck driver, respond to the following statements.**

- |   |                              |
|---|------------------------------|
| 1. I signal for turns and lane changes.                   | ___ Yes ___ Sometimes ___ No |
| 2. I stop completely at stop signs.                       | ___ Yes ___ Sometimes ___ No |
| 3. I stop completely before turning right on red.         | ___ Yes ___ Sometimes ___ No |
| 4. I make decisions based on safety.                      | ___ Yes ___ Sometimes ___ No |
| 5. Others consider me a courteous driver.                 | ___ Yes ___ Sometimes ___ No |
| 6. I turn my head to check blind spots for lane changes.  | ___ Yes ___ Sometimes ___ No |
| 7. I buckle up.   | ___ Yes ___ Sometimes ___ No |
| 8. I honk at bad drivers.                                 | ___ Yes ___ Sometimes ___ No |
| 9. I use my cell phone to talk or text.                   | ___ Yes ___ Sometimes ___ No |
| 10. I need to brake hard or swerve when driving normally. | ___ Yes ___ Sometimes ___ No |
| 11. I am in a hurry when I drive.                         | ___ Yes ___ Sometimes ___ No |
| 12. My friends crash and get tickets.                     | ___ Yes ___ Sometimes ___ No |

**Discussion point:**

Anything but a *Yes* on 1-7 and a *No* on 8-12 may indicate a less than ideal emotional commitment to safety. Agree or disagree? Why?

In some ways, we have a voice that informs us as to what is safe and what is not. For each of the motorcycle riding behaviors below, place in the space provided an **S** for the safety-related voice or an **R** for the risk-related voice.

1. \_\_\_\_\_ Take a curve at the suggested advisory speed.
2. \_\_\_\_\_ Keep up with faster-riding friends in curves.
3. \_\_\_\_\_ Ride at the speed limit on a freeway.
4. \_\_\_\_\_ Stop beyond the stop line at an urban intersection.
5. \_\_\_\_\_ Aggressively challenge a decreasing radius curve.
6. \_\_\_\_\_ Ride at 72 mph on a freeway where speed limit is 65 mph.
7. \_\_\_\_\_ Honk at a driver who cuts you off in traffic.
8. \_\_\_\_\_ Use a following distance of less than two seconds.
9. \_\_\_\_\_ Pass in a no-passing zone.
10. \_\_\_\_\_ Ride at a speed where traffic builds up behind you.
11. \_\_\_\_\_ Ride past a blind intersection without slowing.
12. \_\_\_\_\_ Use turn signals for turns and lane changes.
13. \_\_\_\_\_ Roll through a stop sign.
14. \_\_\_\_\_ Use high beams when an oncoming driver doesn't dim theirs.
15. \_\_\_\_\_ Park in a handicapped parking space.
16. \_\_\_\_\_ Use the street like a personal race track.
17. \_\_\_\_\_ Ride while thinking about work issues.

We become what we think about, and what we think about is shown by our behavior. Although there may be no specific answer for the voice that dominates in the above behaviors, a rider likely knows the difference between proper and improper choices.

**Situational Awareness 1: Curve**

Group 1: What key factors could interact to form a collision trap or provide an escape path?

Group 2: In what way do the 2-4-12 second visual leads apply?

Group 3: How does search-setup-smooth apply?

**Situational Awareness 2: Sharp Turn**

Group 2: What key factors could interact to form a collision trap or provide an escape path?

Group 3: In what way do the 2-4-12 second visual leads apply?

Group 1: How does search-setup-smooth apply?

**Situational Awareness 3: Curve**

Group 3: What key factors could interact to form a collision trap or provide an escape path?

Group 1: In what way do the 2-4-12 second visual leads apply?

Group 2: How does search-setup-smooth apply?

**Situational Awareness 4: Intersection**

Group 1: What key factors could interact to form a collision trap or provide an escape path?

Group 2: In what way do the 2-4-12 second visual leads apply?

Group 3: How much of a time-and-space safety margin exists?

**Situational Awareness 5: Intersection**

Group 2: What key factors could interact to form a collision trap or provide an escape path?

Group 3: In what way do the 2-4-12 second visual leads apply?

Group 1: How much of a time-and-space safety margin exists?

**Situational Awareness 6: Curve**

Group 3: What key factors could interact to form a collision trap or provide an escape path?

Group 1: In what way do the 2-4-12 second visual leads apply?

Group 2: How does search-setup-smooth apply?

**TRAFFIC CONTROLS & ROADWAY FEATURES****ROADWAY USERS****SURFACE CONDITIONS****ESCAPE PATHS**

Directions: For each behavior, note some reasons for a rider’s choice. Then complete the statement in the last column.

Rider Behavior	Reasons to do it	Reasons not to do it	My choice is to
1. Wear a quality helmet			
2. Wear full riding gear in addition to a helmet			
3. Be overly aggressive in curves			
4. Ride buzzed			
5. Ride distracted			
6. Be a low-risk rider			
7. Stunt in public			
8. Be affected by peers			
9. Take formal training			

# QUICK TIPS



## PRETEND YOU ARE INVISIBLE

If you ride a motorcycle, you know that out on the road you might as well be transparent, because car drivers often look right past you. They might notice the car or truck behind you, but *you*, in all your "narrowness," may not register in the visual cortex of even the most alert drivers.

That's why an oncoming car driver might turn left in front of you at an intersection.



That's also why a driver in the next lane, even if they turn and look in your direction before changing lanes, might veer into your lane.

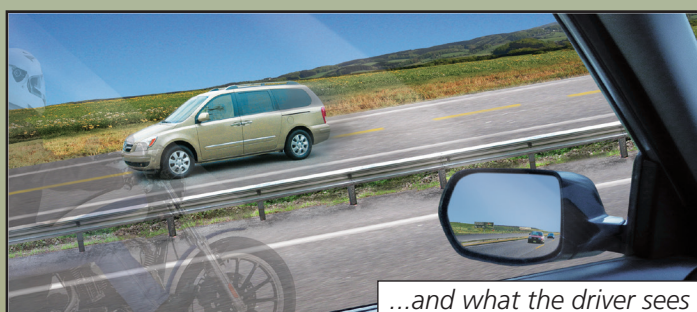

Sadly, drivers might behave this way even when they're not distracted by their cell phone, GPS, satellite radio, or other form of in-car infotainment. So how do you compensate for being "invisible" to drivers?

Be as conspicuous as possible. Wear bright clothing and a light-colored helmet. Always have your headlight on, and use your high beam or an aftermarket headlight modulator during the day (where allowed).

Take an approved rider training course. Learn how to maneuver your motorcycle in normal and emergency situations, and practice braking and swerving maneuvers often. Also understand that safe riding depends as much on the mental skills of awareness and judgment as it does on the physical skill of maneuvering the machine; respond early to possible hazards instead of having to react instantly to an emergency.

Pretend you're invisible. If you assume others on the road *can't* see you, and any car that *can* hit you *will* hit you, you will tend to ride in a hyper-aware mindset and learn to notice every detail in your surroundings. In other words, you will take extra responsibility for your safety and ride defensively. You will vary your speed and lane position to place yourself in the best spot on the road to avoid collisions, plan escape paths in case a driver violates your right-of-way, cover your brake controls to quicken your reactions, use your horn to alert a driver who doesn't notice you, and always ride within your limits.

**CAR DRIVERS ONLY SEE WHAT THEY EXPECT TO SEE, AND MOST DON'T EXPECT YOU TO BE PART OF THE TRAFFIC MIX. RIDE WITH THE RIGHT SKILLS, STRATEGIES, AND ATTITUDE. BE SEEN – BE SAFE.**



Using iTunes, search the iTunes Store for “Motorcycle Safety Foundation” to find our Apps, iBooks, and iTunes U Courses.

## iPhone & iPad Apps



### Dr. Jim's Riding Tips

Dr. Jim's Riding Tips is an educational app that uses existing Motorcycle Safety Foundation self-paced safety lessons to help current motorcycle owners improve their riding skills. Created by Dr. James Heideman, MSF's director of licensing programs, the app incorporates Heideman's 10-video series, which is based on the MSF long-standing publication, “You and Your Motorcycle: Riding Tips.” It allows motorcyclists to use their own motorcycles to practice basic maneuvering and braking techniques at low speeds in a practice riding area of their choosing. Additionally, the mobile app shows the user how to properly prepare the riding area, set up the paths of travel and conduct the drills. MSF's goal with Dr. Jim's Riding Tips is two-fold: to make accessing and understanding these basic motorcycling practice drills as easy as possible, and to help riders prepare for their state's licensing test. The only prerequisite skill necessary is the basic ability to ride a motorcycle, including experience using the controls.

## iBooks



### Rider Choices

An effective discussion tool to help a friend or family member have a serious conversation with a prospective motorcycle rider about a safe way forward. From risk management principles to training, motorist awareness, personal protective gear, and even a ‘Contract for Safety’ that both parties can sign to affirm the wise choices the parties agree to, Rider Choices facilitates a meaningful discussion, one that can lead to an informed decision about whether to ride.

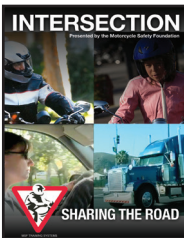

### Intersection

This book is intended to increase your awareness of motorcyclists and scooter riders on the roadway. It illustrates potentially hazardous situations through the eyes of different types of motorists and illustrates why intersections in particular can be so dangerous. The main theme is that all motorists, regardless of their driving experience or the type of vehicle they drive, need to be aware of motorcyclists sharing the road with them.

## Instructional Video



### Ride Along with Dr. Ray

In the twelve-part “Ride Along with Dr. Ray” video series ([msf-usa.org/RideAlong.aspx](http://msf-usa.org/RideAlong.aspx)), you can get inside the mind of MSF's Dr. Ray Ochs as he rides along a variety of Southern California roads and deals with situations that motorcyclists face every day. As you listen to his stream-of-consciousness narration, you'll see how he applies decades' worth of MSF's collective wisdom to make his rides safer and more fun. The videos supplement our hands-on courses and better illustrate the Search/Evaluate/Execute (“SEE”) strategy. Suburban roads, narrow rural roads, curvy mountain roads, construction zones, multi-lane highways, carpool lanes, complex intersections, passing maneuvers: these locations and scenarios help viewers examine Dr. Ray's safety-first approach to enjoying the world on two wheels. The twelve videos range from 5½ to 16 minutes long. So, pull up a chair, dim the lights, and have fun as you Ride Along With Dr. Ray!

## iTunes U – Free Online Courses

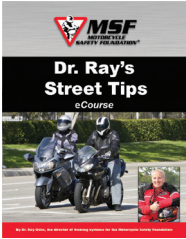

### Dr. Ray's Street Tips eCourse

Dr. Ray's Street Tips consists of 40 brief, practical lessons covering various aspects of motorcycle ownership, inspection and set-up, riding techniques, typical traffic situations, special hazards, and motorcycling theory. Most of the lessons include photos or technical diagrams; some are accompanied by video clips. The 40 lessons have been separated into five categories to constitute a five-week course.

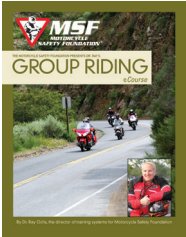

### Dr. Ray's Guide to Group Riding eCourse

This course is practical instruction for anyone organizing or participating in a group ride. The course provides a wide array of tips to help ensure a fun and safe group ride, from where to place your bike on the roadway to how to communicate with the rest of the group while underway. Along with guidelines for organizing the ride and proper formations in complex traffic situations, 18 video clips are included which depict common group riding scenarios. The course concludes with a quiz to help you review the critical information on safety, rules of the road and general group ride courtesies.

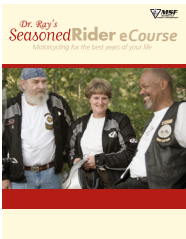

### Dr. Ray's SeasonedRider eCourse

In response to the continuing increase in the average age of motorcyclists (now over 40 years of age), MSF has developed Dr. Ray's SeasonedRider eCourse to help riders stay safe through all phases of their life. Aging affects mental and physical skills, and this course can help riders compensate for the decline of both types of skills to extend their enjoyment of motorcycling into their twilight years.

## Textbook

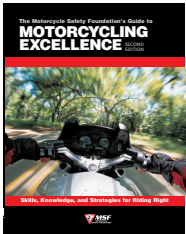

In a clear, engaging style with detailed diagrams and full-color photographs and illustrations, **MSF's Guide to Motorcycling Excellence, 2nd Edition** complements *RiderCourse* instruction and addresses rider attitude, protective riding gear, pre-ride inspection, and basic and advanced street skills in a deeper manner. Tips on how to create a "space cushion" to avoid traffic hazards, stop quickly, manage traction, and much more are included. The book also features advice from legendary racers and other experts on various aspects of motorcycling. 192 pages.

## Host-An-Event Kits

Your learning doesn't stop when you've completed the Basic *RiderCourse*. The Motorcycle Safety Foundation offers refresher hands-on rider courses (such as the *Advanced RiderCourse*) as well as several self-contained classroom-style safety programs ("kits") and publications. These kits can help you learn more, and you can use them to teach others whether you're a riding club leader, a schoolteacher, or just someone who enjoys riding a motorcycle. Please visit our website ([msf-usa.org](http://msf-usa.org)) to obtain these items and other information that can enhance your safety and enjoyment.



The **Intersection – Motorist Awareness** kit is MSF's newest approach to enhancing motorist awareness of motorcycles. The program combines personal stories

and character development with a dramatic new look at a crash scene that's all too common. The DVD contains three separate 13-minute versions to appeal to teens (via driver education classes), adults (via traffic schools), and commercial drivers (via employee orientation). Includes Leader's Guide, 10 Participant's Guides, and 25 Quick Tips brochures.



The **Share the Adventure – Group Riding** kit describes how to put safety first whenever participating in a group ride. Learn about ride preparation and

organization, pre-ride meetings, hand signals, and proper riding formations in complex traffic situations. The kit includes one Leader's Guide, 10 student workbooks, and a 16-minute DVD video that depicts common group riding scenarios.

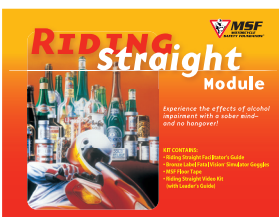

The **Riding Straight – Alcohol Awareness** kit is a curriculum you can present to all roadway users to address the serious issue of impaired riding/driving. The program

features interactive Fatal Vision® Goggles so participants can experience alcohol impairment (at a 0.08 BAC level) with a sober mind...and *no hangover*. This fun demonstration shows that even legal levels of intoxication can have serious consequences. The kit also contains a Facilitator's Guide, a 12-minute DVD video, and a roll of MSF floor tape to use with the goggles for conducting the "sobriety test."



The **Riding Straight– Marijuana Awareness** kit addresses the hazards of mixing motorcycling and marijuana via an artificially created experience of impairment. The Kit allows

facilitators to develop the best activities to meet the needs of a variety of audiences in venues including riding clubs, high schools and motorcycle events. Contains Leader Guide, Fatal Vision® Marijuana Simulation Experience Goggle, 6 Activity Balls, 4 Maze Pads, and Floor Mat with 12 Blinking Activity Lights.

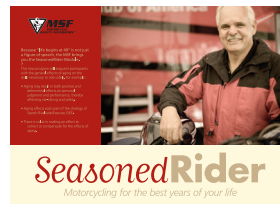

The **SeasonedRider – Aging Awareness** kit is a fun, activity-based learning program designed to help riders assess and compensate for the effects of aging on

their ability to effectively manage risk when operating a motorcycle. The kit includes an award-winning 13-minute DVD video, Facilitator's Guide, and props for several learning activities. Though the activities are targeted at riders over the age of 40, the sessions are appropriate for operators of any age and any type of vehicle.



The **StreetSmart – Rider Perception** kit is an engaging program that helps riders improve their perception. The kit contains a Leader's Guide,

10 Participant Workbooks, four floor mats, a deck of large playing cards and a CD containing perception tests for the classroom powerpoint presentation. A preview of the perception tests is available on our website.



msf-usa.org • 949.727.3227

Edition 1.0, Fifth Printing  
©2014 Motorcycle Safety Foundation  
MSCU4401